

Digital Indicator

SD16A Series

Instruction Manual



Please ensure that this instruction manual is given to the final user of the instrument.

Preface

Thank you for purchasing Shimaden products.

Please check that the delivered product is the correct item that you ordered.

This instruction manual is meant for those who will be involved in the wiring, installation, operation and routine maintenance of the SD16A series, and describes about cautions, mounting, wiring, functions, and operation.

Please observe the contents, and always keep the manual close at hand when handling this instrument.

The following headings give a description of matters requiring user attention concerning safety, damage to machines and equipment, additional explanations and commentaries are described under the following headings.

	WARNING	Items concerning matters that may lead to an accident producing human injury or death, if the warning is not observed.
	CAUTION	Items concerning matters that may lead to an accident producing damage to machines or equipment, if the caution is neglected.

Note

Note

Additional explanations and commentaries.

Contents

Preface.....	1
Contents.....	1
Safety Cautions.....	1
1. Introduction.....	2
1-1. Check before use.....	2
1-2. Notes for use.....	2
2. Installation and wiring.....	2
2-1. Installation site (environmental conditions).....	2
2-2. Mounting.....	2
2-3. External dimensions and panel cutout.....	2
2-4. Wiring.....	2
2-5. Terminal arrangement.....	3
3. Names and functions for front panel.....	3
3-1. Names.....	3
3-2. Functions.....	3
4. Measuring range code table.....	3
5. Error messages.....	3
6. Instruction for each screen.....	4
6-1. Screen sequences.....	4
6-2. Power ON Screen Group.....	5
6-3. Mode 0 Screen Group.....	5
6-4. Mode 1 Screen Group.....	5
7. Optional features overview.....	7
7-1. Alarm output.....	7
7-2. Analog output.....	7
7-3. Sensor power supply.....	7
8. Specification.....	8

Safety Cautions

WARNING

- The SD16A Series digital indicator are designed for industrial use to control temperature, humidity and other physical values. Do not apply this instrument to other objects in a way that may cause grave effects on human safety.
- In using this product, be certain to house it, for example, in a control panel, so that the terminals cannot come into contact with personnel.
- Do not take this instrument out of its case or put your hand or any conductor inside the case. Such conduct may lead to an accident that endangers life or causes serious injury due to electric shock.

CAUTION

- To avoid damage to the connected equipment, facilities or the product itself due to a fault of the product, safety countermeasure must be taken before usage, such as proper installation of the fuse and the overheating protection device.
- An alert symbol is printed on the terminal nameplate attached to the case. It warns not to touch the electrical charging parts when the power is being supplied, so as to avoid the risk of electrical shock.
- Install a switch or breaker on the external source power circuit connecting to the source power terminal as a means to shut down the power. The switch or breaker should be installed adjacent to the instrument in a position that allows the operator easy access.
- Regarding the fuse:
Since this instrument has no built-in fuse, make sure to install a fuse in the electric circuit connecting to the source power terminal. Install the fuse in a position between the switch or breaker, and the instrument and attach it to the L side of the source power terminal. Fuse Rating: 250V AC 1.0A/Time-lag (T) or Medium Time-lag (M)
- The load of voltage and current to be applied to the output terminal (analog output) and the alarm terminal must be within the rated range. If the range is exceeded, the instrument will overheat causing the risk of the instrument being damaged and its life reduced. As for the rating, please refer to "8. Specification."
The unit connected to the output terminal should conform to the requirements of IEC61010-1.
- Do not apply over-rated voltage or current to the input terminal. That will cause the risk of the instrument being damaged and its life reduced. As for the rating, please refer to "8. Specification."
In case the input type is voltage (mV or V) or current (4 - 20mA), the unit connected to the output terminal should conform to the requirements of IEC61010-1.
- Take care to prevent metal or other foreign matter from obstructing the ventilating hole for heat radiation. It will cause damage to the instrument and may even result in fire.
- Do not block the ventilating hole. Also avoid dust accumulation. Any rise in temperature or insulation failure may result in a risk of the instrument being damaged and its life reduced. As for the clearance space for installing the instrument, refer to "2-3 External dimensions and panel cutout."
- Repeating withstanding tests on voltage, noise, surging may lead to the deterioration of the instrument, so please be careful.
- Strictly refrain from remodeling and using the instrument improperly.
- It takes 30 minutes to display the correct temperature after applying power to the digital Indicator. (Therefore, turn the power on more than 30 minutes prior to the operation.)

Copyright © SHIMADEN CO., LTD. All rights reserved

产品中有毒有害物质或元素的名称及含量

部件名称	有毒有害物质或元素					
	铅 (Pb)	汞 (Hg)	镉 (Cd)	六价铬 (Cr (VI))	多溴联苯 (PBB)	多溴二苯醚 (PBDE)
印制电路板	×	○	○	○	○	○
电子元器件	×	○	○	○	○	○
接线端子	○	○	○	○	○	○
外壳	○	○	○	○	○	○

○:表示该有毒有害物质在该部件所有均质材料中的含量均在 SJ/T 11363-2006 标准规定的限量要求以下。
×:表示该有毒有害物质至少在该部件的某一均质材料中的含量超出 SJ/T 11363-2006 标准规定的限量要求。

1. Introduction

1-1. Check before use

Although the instrument passes through quality checks before shipment, when the instrument is delivered, please confirm the type code number, check the external conditions and the list of accessories to make sure that there is no apparent damage or discrepancy.

Confirmation of the type code

Check the type code printed on the label on the packing case with the following table to confirm that the delivered goods meet your order.

Item	Code	Specifications
1. Series	SD16A-	48 × 96 DIN size Digital Indicator
2. Input (Note 1)	8	Universal-input • Thermocouple • R.T.D. (Pt100, JPt100) • Voltage (Input impedance 500 kΩ min.) • 0 - 10mV DC • 0 - 5, 1 - 5, 0 - 10V DC Refer to "4. Measuring range code table" for details. In case voltage input, scaling/reverse scaling is available. (Note 2)
	4	Current 4 - 20mA DC An external receiving resistor is provided. Scaling/reverse scaling available (Note 2)
3. Power supply	90-	100 - 240V AC ± 10% (50/60Hz)
	08-	24V AC (50/60Hz) /DC ±10%
4. Alarm output (option)	0	None
	1	Separate setting/separate output 2-point (a-contact, "COM" used commonly) Contact rating 240V AC 1.5A/resistive load
5. Analog output or sensor power supply (option) (Note 3)	0	None
	3	0 - 10mV DC Output resistance 10Ω
	4	4 - 20mA DC Load resistance 300Ω max.
	6	0 - 10V DC Load current 1mA max.
	8	Sensor power supply 24V±3V DC 25mA max.
6. Communication function (option)	0	None
	5	RS-485
	7	RS-232C
7. Remarks	0	Without
	9	With

- Note 1 The instrument supports full universal input; however please select one of two codes, as an external receiving resistor (250Ω) is supplied for current input. If no external receiving resistor is required, a code 8 specification product can be used for current input.
- Note 2 Scaling range: -1999 - 9999 digit
Span: 10 - 10000 digit
- Note 3 When the 08 power supply code (24V AC/DC) is selected, the sensor power supply cannot be selected.

Accessory list check

- Unit label seal 1 sheet
- Instruction Manual 1 copy
- Communication Interface Manual (in case the optional communication option is selected) 1 copy

Note Contact our local agent or exp-dept@shimaden.co.jp via e-mail for any problems about the product, accessories or related items.

1-2. Notes for use

- Avoid operating the front panel keys with hard or sharp objects. Lightly touch the operating keys with your fingertips for operation.
- When cleaning, do not use a solvent such as a thinner. Wipe the instrument with a dry cloth lightly.

2. Installation and wiring

2-1. Installation site (environmental conditions)

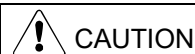

Do not install the instrument in such environmental conditions as those listed below. Otherwise, damage may be caused to the instrument, even resulting in fire.

- Flammable or corrosive gas, oil soot or dust that deteriorates the insulation is generated or abundant.
- Ambient temperature is below -10°C or above 50°C.
- Ambient humidity is higher than 90% RH, or below dew point.
- Strong vibrations or impacts are generated or transferred.
- High-voltage power lines exist in the neighborhood, or induction interference.
- Exposure to direct sunlight or dew drops.
- The elevation is above 2000m.

Note The environmental conditions fall under transient over voltage category II of IEC 60664, and the pollution degree is "2".

2-2. Mounting

- 1 Cut a fitting hole by referring to the panel cutout dimensions in section 2-3. The applicable thickness of the panel is 1.0 - 4.0mm.
- 2 Insert the indicator into the hole from the front of the panel, as it has catching claws to fix it in position.

Note As the SD16A is a panel installation type indicator, use it by mounting on a panel.

2-3. External dimensions and panel cutout

External dimensions

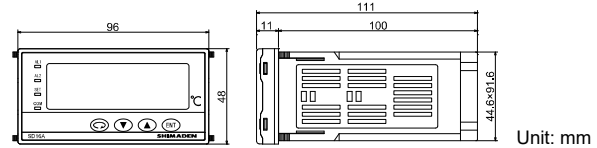

Panel cutout

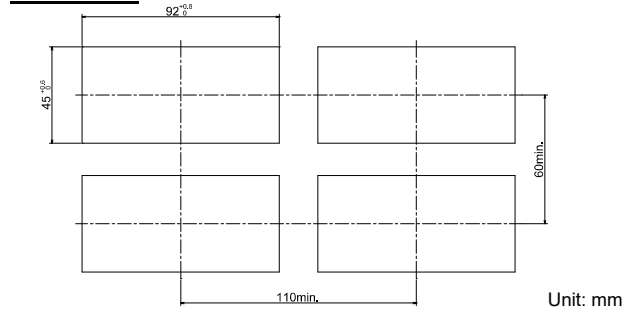

2-4. Wiring



- When wiring the unit, be sure to cut the power supply OFF, or there will be a risk of electric shock.
- Make sure the protective conductor terminal (⊕) is grounded. Otherwise, a serious electric shock may result.
- After completing the wiring, do not touch the terminals and electrically charged parts while the power is ON.

- Make wiring according to the layout in "2-5. Terminal arrangement."
- Use ring tongue terminals of 7mm or narrower width to meet M3.5 screws.
- In case of thermocouple input, use a compensation wire with the type of thermocouple selected. The external resistance should be 100Ω or less.
- In case of R.T.D. input, the resistance value per lead wire should be 5Ω or less, and all three wires should have the same resistance value.
- Avoid arranging the input signal line to pass through the same conduit or duct with high-voltage power lines.
- The shield wire (one-point grounding) is effective to eliminate electrostatic induction noises.
- An effective way to eliminate the magnetic induction noises is to twist the input wire in short and equal intervals.
- For the source power connection, use a wire or cable having a cross-section of 1mm² or larger, and a performance capacity equivalent to 600V vinyl insulation wire.
- The grounding wire should have a cross-section of 2mm² or larger, and the grounding work should ensure a ground resistance of 100Ω or less.
- The symbol ⊕ expresses the functional earth terminal. Please connect it to the ground as much as possible to avoid the adverse impact from noise.
- Screw the terminal connection securely. Tightening torque 1.1 · Nm (11kgf · cm)
- Noise filter
In case the instruments are affected by the power supply noise, install a noise filter to avoid operational errors. Mount the noise filter on the grounded panel and connect the noise filter output and the power supply terminal of the indicator with the minimum possible distance.

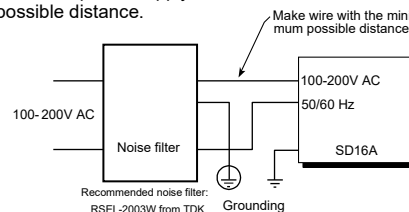

2-5. Terminal arrangement

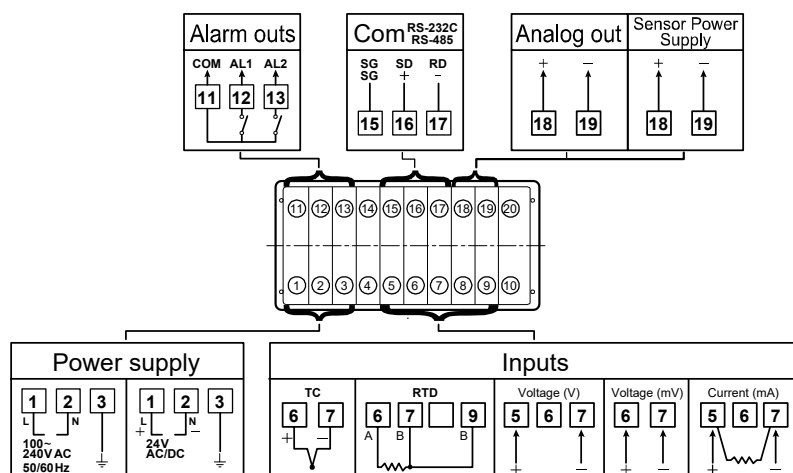

Note Do not connect other than the specified input type to terminal.

3. Names and functions for front panel

3-1. Names

Front panel

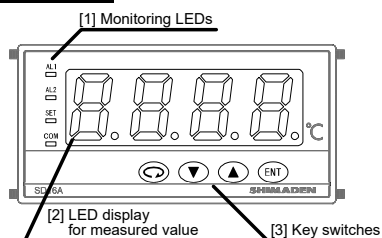

3-2. Functions

[1] Monitoring LEDs

- AL1 (Alarm 1) output monitoring LED (red)
The LED lights when the assigned alarm is ON.
- AL2 (Alarm 2) output monitoring LED (red)
The LED lights when the assigned alarm is ON.
- SET (parameter setting) monitoring LED (green)
The LED lights when the screen displayed is not the basic screen (0-0).
- COM (communication) monitoring LED (green)
The LED lights when the communication mode is on remote control.

[2] LED display for measured value (red)

- The current PV value is displayed on the basic screen (0-0).
- The type of parameters is displayed on each parameter display screen.
- The set value is displayed on each parameter setting screen.

[3] Key switches

	Parameter key <ul style="list-style-type: none"> On a display screen, shifts the screen to the next. Switches from Mode 0 screen group/Mode 1 screen group to Mode 1 screen group/Mode 0 screen group. By pressing this key for two seconds or longer on screen 0-0 or screen 1-0, shifts to the screen 1-0 or to the screen 0-0 respectively.
	Down key <ul style="list-style-type: none"> On a setting screen, decrements the value. The last digit decimal point blinks until the value is registered by pressing the Entry key.
	Up key <ul style="list-style-type: none"> On a setting screen, increments the value. The last digit decimal point blinks until the value is registered by pressing the Entry key.
	Entry key <ul style="list-style-type: none"> On a setting screen, registers the value that is modified by the Up/Down key. The last digit of the decimal point blinks until this registration by pressing the Entry key. Shifts between a display screen and the setting screen. In this case, the light of the last digit of decimal point goes out.

4. Measuring range code table

Input type	Code	Measuring range (°C)	Measuring range (°F)	Note		
Universal Input (Note 1)	Thermocouple	B	0 - 1800	0 - 3300	Note 2	
		R	0 - 1700	0 - 3100		
		S	0 - 1700	0 - 3100		
		K	04	-199.9 - 800.0	-300 - 1500	
			05	0 - 1200	0 - 2200	
		E	0 - 700	0 - 1300		
	J	0 - 600	0 - 1100			
	T	08	-199.9 - 300.0	-300 - 600	Note 3	
	N	09	0 - 1300	0 - 2300		
	U	10	-199.9 - 300.0	-300 - 600	Note 3	
	L	11	0 - 600	0 - 1100		
	C(WRe5-26)	12	0 - 2300	0 - 4200		
R.T.D	Pt	31	-199.9 - 600.0	-300 - 1100	Note 4	
		32	-100.0 - 100.0	-150.0 - 200.0		
	JPt	33	-199.9 - 500.0	-300 - 1000	Note 4	
		34	-100.0 - 100.0	-150.0 - 200.0		
Voltage	0 - 10mV	71	0.0 - 100.0 Scaling available Scaling range : -1999 - 9999 digit Span : 10 - 10000 digit			
	0 - 5V	81				
	1 - 5V	82				
	0 - 10V	83				
Current	4 - 20mA	95				

Note 1 In case universal input type is selected, K (Code 05, 0 - 1200°C) is set at factory default.

Note 2 The accuracy of 400°C or below 752°F of thermocouple B is not guaranteed.

Note 3 The accuracy of thermocouple T or U is $\pm(0.5\%FS+1\text{digit})$ at above -100°C and 0°C or below, and $\pm(1\%FS+1\text{digit})$ at -100°C or below.

Note 4 In case of Pt (Code 31) or JPt (Code 33), scale over occurs at -240.0°C (-400°F).

5. Error messages

One of the following error messages is displayed on the basic screen (0-0):

HHHH	When the thermocouple or A of R.T.D. is burnt out. Also indicated when the PV value exceeds the higher-limit of the measuring range by about 10%
LLLL	When the B of R.T.D. (terminal No.7) is burnt out. When the PV value is below the lower-limit of the measuring range by about 10%, for such a reason as the reverse polarity of the input wiring type.
CUHH	When the cold junction (CJ) is abnormal on the higher side in the thermocouple input.
CU LL	When the cold junction (CJ) is abnormal on the lower side in the thermocouple input.
b---	When the B of the R.T.D. (terminal No.9) is burnt out, or two or more wires of A, B, B are broken.

6. Instruction for each screen

6-1. Screen sequences

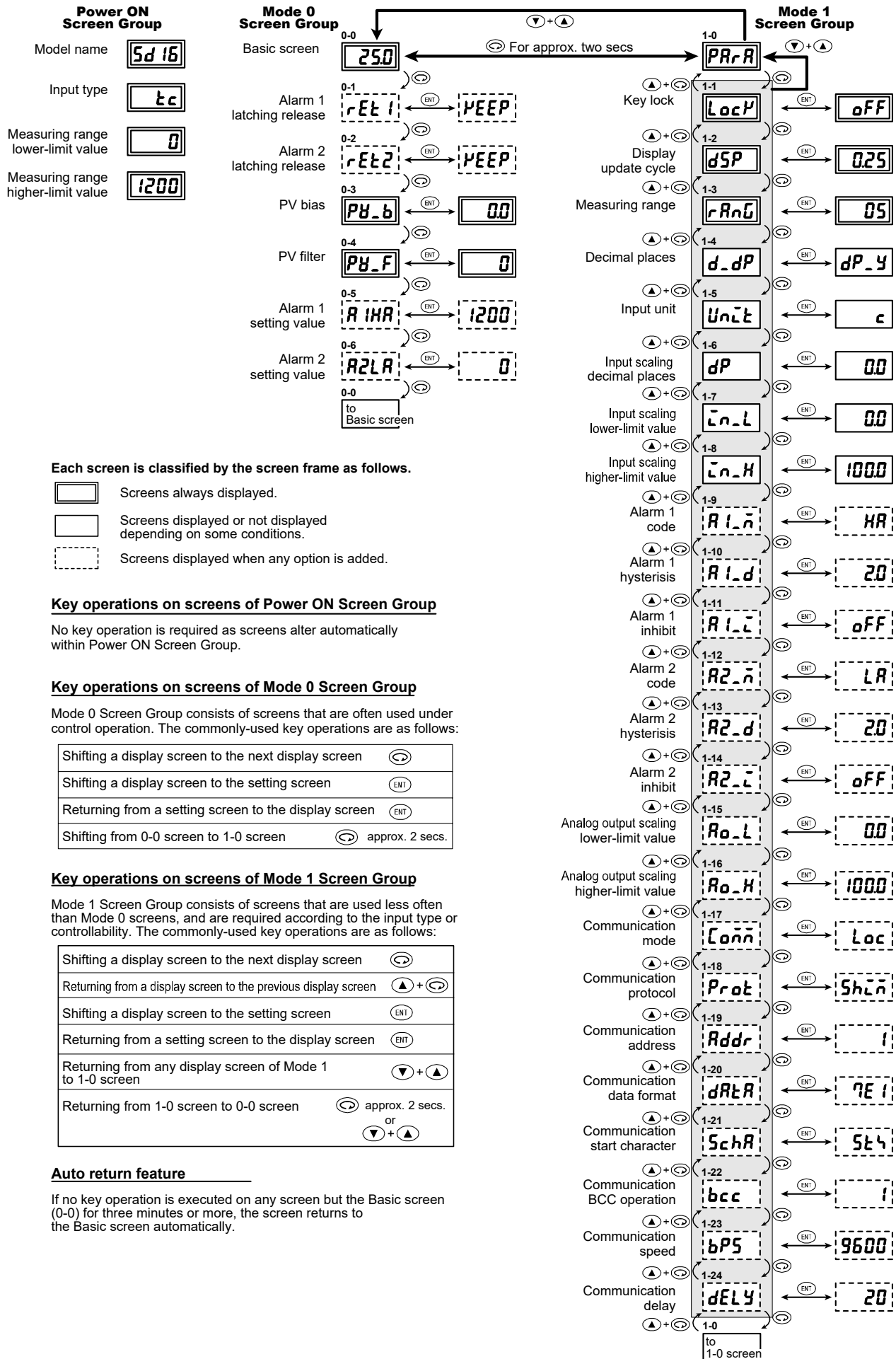

6-2. Power ON Screen Group

The following information is displayed automatically.

Model name

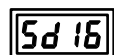

The model name (SD16A) is displayed.

Input type

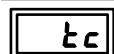

The input type is displayed.

The type is either TC (thermocouple), Pt (R.T.D.), mV, V, or mA.

Measuring range, lower-limit value



The lower-limit value of the input is displayed.







Measuring range, higher-limit value



The higher-limit value of input is displayed.

6-3. Mode 0 Screen Group



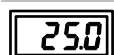

The following informational icons are used from this sub-section.

	Setting/display is available when the alarm option is supported.		Setting/display is available when the analog output option is supported.
	Setting/display is available when the communication option is supported.		
	Setting/display is available when the voltage or current input is specified.		Setting/display is not available when the voltage or current input is specified.
	Setting range		Initial value

0-0 Basic screen



PV (measured value) is displayed.

Note	In case the Alarm 1 or 2 signal is output with the latching feature, use  +  key on this screen to release the Alarm 1 latching, or use  +  key on this screen to release the Alarm 2 latching.
-------------	---

0-1 Alarm 1 latching release

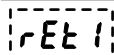



This screen is displayed when Alarm 1 is in the latching state, and is used for releasing it from that state. 

This screen is displayed in case Alarm 1 code (1-1) is selected from the one with latching, and when the instrument is in the latching state. Set the parameter RSET to stop the alarm output.

As for the latching feature, refer to "Latching feature" of "7-1. Alarm output."

KEEP : Alarm output is ON with latching feature.
RSET : Releasing the alarm with latching feature.

Note	The Alarm 1 output signal with latching feature can also be set to OFF by pressing  +  key on the Basic screen (0-0).
-------------	---

 KEEP, RSET

 KEEP

0-2 Alarm 2 latching release

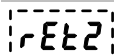



This screen is displayed when Alarm 2 is in the latching state, and is used for releasing it from that state. 

This screen is displayed in case Alarm 2 code (1-12) is selected from the one with latching, and when the instrument is in the latching state. Set the parameter at RSET to stop the alarm output.

As for the latching feature, refer to "Latching feature" of "7-1. Alarm output."

KEEP : Alarm output is ON with latching feature.
RSET : Releasing the alarm with latching feature.

Note	The Alarm 2 output signal with latching feature can also be set to OFF by pressing  +  key on the Basic screen (0-0).
-------------	---

 KEEP, RSET

 KEEP

0-3 PV bias

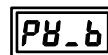

The PV bias value is displayed or can be set.

The value is used for compensating input errors by the sensor, etc. When the value is set, the compensated PV is displayed.

 -1999 - 2000 digit

 0 digit

0-4 PV filter

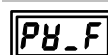

The PV filter time is displayed or can be set.

The value is helpful for reducing the adverse effect of noise from a PV input.

Note	The PV filtering is temporarily disabled when the instrument is recovering from scale over.
-------------	---

 0 - 100 seconds

 0

0-5 Alarm1 setting value

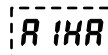

Alarm 1 setting value is displayed or can be set. 

One of the following Alarm 1 action types (1-9) is displayed on the screen.

A1HA : Higher-limit absolute value

A1LA : Lower-limit absolute value

A1H.A. : Higher-limit absolute value (with latching)

A1L.A. : Lower-limit absolute value (with latching)

Note	This screen is not displayed when non or So (scale over) is selected on Alarm 1 code screen (1-9).
-------------	--

 Measuring range lower-limit to higher-limit value

 Higher-limit value

0-6 Alarm 2 setting value

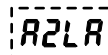

Alarm 2 setting value is displayed or can be set. 

One of the following Alarm 2 action types (1-12) is displayed on the screen.

A1HA : Higher-limit absolute value

A1LA : Lower-limit absolute value

A1H.A. : Higher-limit absolute value (with latching)

A1L.A. : Lower-limit absolute value (with latching)

Note	This screen is not displayed when non or So (scale over) is selected on Alarm 2 code screen (1-12).
-------------	---

 Measuring range lower-limit to higher-limit value

 Lower-limit value

6-4. Mode 1 Screen Group

1-0 Mode 1 initial screen



This is the heading screen of Mode 1 screens.

1-1 Key lock



Key lock status is displayed or can be set. When the key lock is set to ON, parameter value modification is not allowed.

 OFF, ON

 OFF

1-2 Display update cycle



The display update cycle of PV is displayed or can be set.

 0.25 - 5.00 secs. Set by 0.25 secs.

 0.25

1-3 Measuring range



The input type is displayed or can be set. Refer to "4. Measuring range code table" for input type details.

 01 - 12, 31 - 34, 71, 81 - 83, 95

 05 (K, TC 0 - 1200°C)

1-4 Decimal places

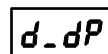

The decimal place with/without status is displayed or can be set.

dp_y : with decimal places

dp_n : without decimal places



Note	In case the measuring range that doesn't support decimal places is specified, this screen is not displayed. Once this setting is modified from "with decimal places" to "without decimal places", the values of input scaling, analog output scaling, alarm setting, alarm hysteresis, and PV bias are rounded to the nearest integer. Then that setting is modified to "with decimal places" again, the value after the decimal places remains 0.
-------------	--

 dp_y, dp_n

 dp_y

1-5 Input unit

Unit The input unit is displayed or can be set. 

R °C, °F **Ini** °C

1-6 Input scaling decimal places

dP The scaling decimal places for voltage/current system input are displayed or can be set. 

Note Other than voltage/current system input, display only.

R nnnn. - n.nnn **Ini** n.n

1-7 Input scaling lower-limit value

Ln_L The scaling lower-limit value for voltage/current input is displayed or can be set. 

Note Other than voltage/current input, display only.
The span between lower-limit and higher-limit is 10 - 10000.
Reverse scaling is available.

R -1999 - 9999 digit **Ini** 0 digit

1-8 Input scaling higher-limit value

Ln_H The scaling higher-limit value for voltage/current input is displayed or can be set. 

Note Other than voltage/current input, display only.
The span between the lower-limit and the higher-limit is 10 - 10000.
Reverse scaling is available.

R -1999 - 9999 digit **Ini** 1000 digit

1-9 Alarm 1 code

Al_n The Alarm 1 action type is displayed or can be set. 

As for action types, refer to "Action type" of "7-1. Alarm output."

non : none
HA : Higher-limit absolute value
LA : Lower-limit absolute value
HA_L: Higher-limit absolute value (with latching)
LA_L : Lower-limit absolute value (with latching)
So : Scale over

Note Once the alarm code is changed, the preset values are initialized. However, they are not initialized when the code is changed HA<->HA_L, or LA<->LA_L.

R non, HA, LA, HA_L, LA_L, So **Ini** HA

1-10 Alarm 1 hysteresis

Al_d The Alarm 1 hysteresis is displayed or can be set. 

Note This screen is not displayed when non or So (scale over) is selected on the Alarm 1 code screen (1-9).

R 1 - 999 digit **Ini** 20 digit

1-11 Alarm 1 inhibit

Al_i The Alarm 1 inhibit status is displayed or can be set. 

Note This screen is not displayed when non or So (scale over) is selected on the Alarm 1 code screen (1-9).

R OFF, ON **Ini** OFF

1-12 Alarm 2 code

Al_n The Alarm 2 action type is displayed or can be set. 

As for action types, refer to "Action type" of "7-1. Alarm output."

non : none
HA : Higher-limit absolute value
LA : Lower-limit absolute value
HA_L: Higher-limit absolute value (with latching)
LA_L : Lower-limit absolute value (with latching)
So : Scale over

Note Once the alarm code is changed, the preset values are initialized. However, they are not initialized when the code is changed HA<->HA_L, or LA<->LA_L.

R non, HA, LA, HA_L, LA_L, So **Ini** LA

1-13 Alarm 2 hysteresis

Al_d The Alarm 2 hysteresis is displayed or can be set. 

Note This screen is not displayed when non or So (scale over) is selected on the Alarm 2 code screen (1-12).

R 1 - 999 digit **Ini** 20 digit

1-14 Alarm 2 inhibit

Al_i The Alarm 2 inhibit status is displayed or can be set. 

Note This screen is not displayed when non or So (scale over) is selected on the Alarm 2 code screen (1-12).

R OFF, ON **Ini** OFF

1-15 Analog output scaling lower-limit value

Ro_L The analog output scaling lower-limit value is displayed or can be set. 

Note Reverse scaling is available.
The same value cannot be set for the lower-limit value and the higher-limit value (on screen 1-16).

R Measuring range lower-limit value to higher-limit value **Ini** Lower-limit value

1-16 Analog output scaling higher-limit value

Ro_H The analog output scaling higher-limit value is displayed or can be set. 

Note Reverse scaling is available.
The same value cannot be set for the lower-limit value (on screen 1-15) and the higher-limit value.

R Measuring range lower-limit value to higher-limit value **Ini** Higher-limit value

1-17 Communication mode

Com The communication mode is displayed or can be set. 

LOC : Local mode. Data can be read out via communication.
COM : Communication mode. Data can be set and read out via communication.

Note Once the communication mode is modified to COM via communication, the setting can no longer be made with front panel keys. However, the modification from COM to LOC is available.
For details, refer to the separated Communication Interface Instruction Manual.

R LOC, COM **Ini** LOC

1-18 Communication protocol

Prot The communication protocol is displayed or can be set. 

SHIM : Shimaden protocol
ASC : MODBUS ASCII
RTU : MODBUS RTU

R SHIM, ASC, RTU **Ini** SHIM

1-19 Communication address

Raddr The communication address is displayed or can be set.

R 1 - 100 **Ini** 1

1-20 Communication data format

dRtR The communication data format is displayed or can be set.

The setting value is composed of three alphanumerical characters.

- Left character : Data length (bits), 7 or 8
- Middle character : Parity, E (even) or N (none)
- Right character : Stop bit, 1 or 2

Note For MODBUS ASCII, specify one of the 7-bit format types. The default value is 7E1.
For MODBUS RTU, specify one of the 8-bit format types. The default value is 8E1.

R 7E1, 7E2, 7N1, 7N2, 8E1, 8E2, 8N1, 8N2 **Ini** 7E1

1-21 Communication start character

SchR The start character of communication data is displayed or can be set.

- STX Start character STX (02H)
- Text end ETX (03H)
- End character CR (0DH)
- ATT Start character @ (40H)
- Text end : (3AH)
- End character CR (0DH)

Note MODBUS ASCII/RTU doesn't use a start character.

R STX, ATT **Ini** STX

1-22 Communication BCC operation

bcc The BCC operation method is displayed or can be set.

- 1 : ADD operation from the start character to the text-end character
- 2 : 2's complement after ADD operation from the start character to the text-end character.
- 3 : XOR operation from after the start character to the text-end character.
- 4 : BCC operation is not performed.

Note MODBUS ASCII/RTU doesn't use BCC.

R 1 - 4 **Ini** 1

1-23 Communication speed

bPS The communication speed is displayed or can be set.

Note In case of 19200 bps, "1920" is displayed on the screen.

R 1200, 2400, 4800, 9600, 19200 bps **Ini** 9600

1-24 Communication delay

dELY The delay time by communication, between time of receiving a command and sending the reply, is displayed or can be set.

R 1 - 100 msec **Ini** 20

7. Optional features overview

7-1. Alarm output

The instrument supports two points of alarm optionally.

Action type

The following alarm output action types (screen 1-9 or 1-12) are supported.

The lower-limit absolute value alarm

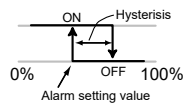

The higher-limit absolute value alarm

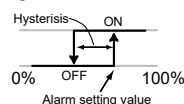

Scale over



Inhibit action

When the alarm output inhibit action is set to ON (on screen 1-11 or 1-14), the inhibit action at power on is performed, as follows.

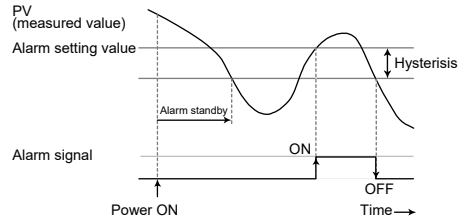

Latching feature

The latching feature outputs the alarm signal constantly once PV is detected in the alarm action region, even if PV is out of the alarm action region later.

Note When PV is in the alarm action region, latching cannot be released. To release the latching, refer to the description of screen 0-0, 0-1, or 0-2.

The latching feature is disabled.

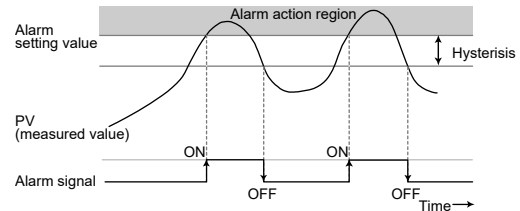

The latching feature is enabled.

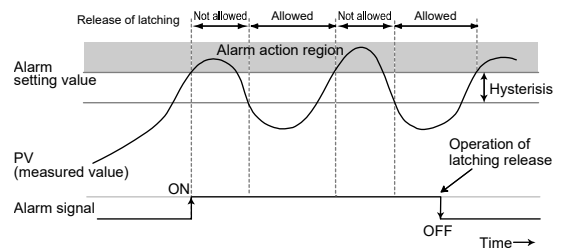

7-2. Analog output

Analog output is a feature that outputs PV value-based analog voltage or analog current. By setting the analog output scaling lower-limit value (screen 1-15) or higher-limit value (1-16), the analog output signal can be gained by PV value-base within a specified measuring range.

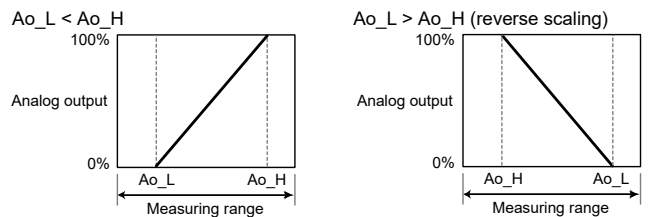

7-3. Sensor power supply

In case the optional DC sensor power supply (24V DC 25mA) is selected, the instrument can be used with the Humidity Sensor H71A/TH71A series. Note that if 08 of power (24V AC/DC) from type code is selected, the sensor power supply cannot be specified.

Wiring example using with Humidity Sensor H71A/TH71A

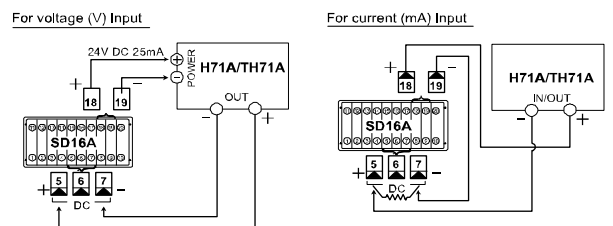

8. Specification

Display	
Digital display	Measured value (PV), 7-segment, Red 4-digit LED
Action indication	SET (green) : lit when parameter value is displayed COM (green) : lit when communication mode is set AL1/AL2 (red) : lit when alarm signal is output
Display accuracy	± (0.3%FS + 1 digit) within measuring range Excluding cold junction temperature compensation accuracy of thermocouple input. The accuracy of 400°C or below 752°F of thermocouple B is not guaranteed. Accuracy of thermocouple T or U is ± (0.5%FS+1digit) at above -100°C and 0°C or below, and ± (1%FS+1digit) at -100°C or below.
Display accuracy maintaining range	23°C±5°C (18 - 28°C)
Display resolution	Differs depending on the measuring range (0.001, 0.01, 0.1, 1)
Measured value display range	-10 - 110% of measuring range (Accuracy is only guaranteed when the value is within the measuring range). For R.T.D. input of -199.9 - 600.0°C: -240.0 - 680.0°C -199.9 - 500.0°C: -240.0 - 570.0°C For thermocouple K of -199.9 - 800.0°C: -273.1 - 900.0°C
Display update cycle	0.25 - 5.00 secs (0.25 secs step) When 0.50 secs or more is set, a difference may occur among the displayed value, the analog output, and the communication data.

Setting	
Setting method	Using four key switches on the front panel Setting protection feature by key lock ON/OFF is provided.
Setting range	Same as the measuring range.

Input	
Input type	Thermocouple, R.T.D., voltage (mV/V). Universal-input
Thermocouple	B, R, S, K, E, J, T, N {U, L (DIN43710)}, C(WRe5-26) For details, refer to the Measuring range code table.
Lead wire tolerable resistance	100Ω max.
Input impedance	500kΩ min.
Burnout	Standard feature (up-scale)
Cold junction compensation accuracy	±1°C (within accuracy maintain range (18 - 28°C)) ±2°C (ambient temperature 5 - 18°C, 28 - 45°C)
R.T.D	JIS Pt100 3-wire type, JPt100 3-wire type
Amperage	Approx. 0.25mA
Lead wire tolerable resistance	5Ω max./wire (each wire should have the same resistance)
Voltage	mV 0 - 10mV DC V 0 - 5, 1 - 5, 0 - 10V DC Input impedance 500kΩ min.
Current	4 - 20mA DC
External receiving resistor	250Ω (supplied if specified)
Input scaling function	Available in case of voltage (mV/V) or current (mA) input. Reverse scaling can be set.
Scaling range	-1999 - 9999 digit
Span	10 - 10000 digit
Decimal places	None, 0.0, 0.00, 0.000
Sampling cycle	0.25 secs
PV bias	-1999 - 2000
PV filter	0 - 100 secs (PV filter is set to OFF when 0 sec)
Isolation	Isolated between input and analog output (sensor power supply), or between input and communication. Not isolated between input and system.

Alarm output (option)	
Number of alarm points	2 points (AL1 and AL2), normally open, COM is commonly used.
Alarm type	One of the following six types can be assigned to each alarm. None, higher-limit absolute value alarm (with latching), higher-limit absolute value alarm (without latching), lower-limit absolute value alarm (with latching), lower-limit absolute value alarm (without latching), Scale over
Setting range	Within measuring range or within scaling range
Alarm action	ON-OFF action
Hysteresis	1 - 999 digit
Inhibit action	ON/OFF can be selected for each alarm output.
Output type	Contact 1a (COM is commonly used)
Rating	240V AC 1.5A (resistive load)
Output update cycle	0.25 secs
Isolation	Isolated between alarm output and input, between alarm output and analog output (sensor power supply), between alarm output and communication, or between alarm output and system. Not isolated between alarm output 1 and alarm output 2.

Analog output (option)	
Analog output type	0 - 10mV (Output resistance 10Ω) 0 - 10V (Load current 1mA max.) 4 - 20mA (Load resistance 300Ω max.)
Output resolution	Approx. 1/14000
Output accuracy	±0.3%FS of display value
Scaling	Within measuring range or within input scaling range (reverse scaling can be set).
Output update cycle	0.25 secs
Isolation	Isolated between analog output and input, between analog output and alarm output, between analog output and communication, or between analog output and system.

Sensor power supply (option)	
Output rating	24V ± 3V DC 25mA max. Depending upon instrument's power ON-OFF status.
Isolation	Isolated between sensor power supply and input, between sensor power supply and alarm output, between sensor power supply and communication, or between sensor power supply and system.
Restrictions	Sensor power supply can't be selected when the analog output is selected. Sensor power supply can't be selected when the power supply 24V is selected.

Communication (option)	
Communication type	RS-232C, RS-485
Communication system	Half duplex asynchronous communication method
Communication speed	1200, 2400, 4800, 9600, 19200 bps
Data format	7E1, 7E2, 7N1, 7N2, 8E1, 8E2, 8N1, 8N2
Communication address	1 - 100
Number of connectable devices	31 devices max. (for RS-485)
Delay	1 - 100 msec
Communication protocol	Shimaden standard protocol, MODBUS ASCII, MODBUS RTU (start character and BCC operation method can be selected for Shimaden standard protocol).
Isolation	Isolated between communication and input, between communication and alarm output, between communication and analog output (sensor power supply), or between communication and system.

Miscellaneous		
Data storage	By nonvolatile memory (EEPROM).	
Ambient conditions for use	Temperature	-10 - 50°C
	Humidity	90%RH max. (no dew condensation)
	Height	2000m above sea level or lower
	Over voltage category	II
	Degree of pollution	2 (IEC60664)
Power supply voltage (frequency)	100 - 240V AC ± 10% (50/60Hz) 24V AC (50/60Hz)/DC ± 10% (option)	
Power consumption	11VA (100 - 240V AC) 8VA (24V AC) 5W (24V DC)	
Appli-able standard	Safety	IEC61010-1 and EN61010-1 IEC61010-2-030 and EN61010-2-030
	EMC	EN61326-1
Dust proof /drip proof	IP66 equivalent (Panel thickness :1.2-3.2mm)	
Isolation resistance	Between input/output terminals and power terminal: 500V DC 20MΩ min. Between input/output terminals and ground terminal: 500V DC 20MΩ min.	
Dielectric strength	Between input/output terminals and power terminal: 3000V AC for one minute. Between power terminal and ground terminal: 1500V AC for one minute.	
Case material	Black PPE resin molding	
External dimensions	H48 x W96 x D111 mm (inside of panel: 100mm)	
Mounting	Push-in panel (one-touch mount)	
Panel thickness	1.0 - 4.0 mm	
Panel cutout	H45 x W92 mm	
Weight	Approx. 250g	

The contents of this manual are subject to change without notice.

Temperature and Humidity Control Specialists

SHIMADEN CO., LTD.

<http://www.shimaden.co.jp/>

Head Office: 2-30-10 Kitamachi, Nerima-ku, Tokyo 179-0081 Japan
Phone: +81-3-3931-7891 Fax: +81-3-3931-3089 E-mail:exp-dept@shimaden.co.jp

Any questions should be directed to your local agent, or send an e-mail to exp-dept@shimaden.co.jp.

Printed in Japan