

SR23 Series  
Digital Controller  
Instruction Manual  
(Detailed version)

1-input

Thank you for purchasing the Shimaden SR23 Series Digital Controller. Check that the delivered product is the correct item you ordered. Do not begin operating this product until you have read and thoroughly understood the contents of this Instruction Manual (Detailed version).

**SHIMADEN CO., LTD.**

MSR023-E01-D  
July. 2017



## Request

Make sure that this Instruction Manual (Detailed version) is given to the final user of the device.

Keep this manual at the work site during operation of the SR23 Series.

## Preface

This Instruction Manual describes the basic functions and how to use "1-input: 1-output/2-output" SR23 Series Controllers. For details on "2-input: 1-output/2-output" and "servo output," refer to separate manuals.

This Instruction Manual is meant for those will be involved in the wiring, installation, operation and routine maintenance of the SR23 Series. This manual describes the handling, installation and wiring procedures for operation.

While using this device, you should always follow the instructions written in this manual.

For safety precautions and potential damage to equipment and/or facilities, additional instructions are indicated by the following headings.

## Safety Precautions



### Warning

The SR23 Series digital controllers are control instruments designed for industrial use to control temperature, humidity and other physical values.

It must not be used in any way that may adversely affect the safety, health or working conditions of those who come into contact with the effects of its use. When used, adequate and effective safety countermeasures must be provided at all times by the user. No warranty, express or implied, is valid when this device is used without the proper safety countermeasures.



### Warning

- ◆ Before you start to use this device, install it in a control panel or the like and avoid touching the terminals.
  - ◆ Do not open this device's case, and touch the boards or inside of the case with your hands or a conductor. The user should never repair or modify this device. Doing so might cause an accident that may result in death or serious bodily injury from electric shock.
- 
-



## Caution

To avoid damage to connected peripheral devices, facilities or the product itself due to malfunction of this device, safety countermeasures such as proper installation of the fuse or installation of overheating protection must be taken before use. No warranty, express or implied, is valid in the case of use resulting in an accident without having taken the proper safety countermeasures.

- ◆ The warning mark on the plate affixed on the casing of this device warns you not to touch charged parts while this device is powered ON. Doing so might cause an electric shock.
- ◆ A means for turning the power OFF such as switch or a breaker must be installed on the external power circuit connected to the power terminal on this device.  
Fasten the switch or breaker at a position where it can be easily operated by the operator, and indicate that it is a means for powering this device OFF.
- ◆ This device does not have a built-in fuse. Install a fuse that conforms to the following rating in the power circuit connected to the power terminal.

**Fuse rating/characteristics: 250 VAC 1.0A/medium lagged or lagged type**

- ◆ When wiring this device, tighten the terminal connections firmly.
- ◆ Use the device with the power voltage and frequency within their rated range.
- ◆ Do not apply a voltage or current outside of the input rating to the input terminal.  
Doing so might shorten the service life of this device or cause it to malfunction.
- ◆ The voltage and current of the load connected to the output terminal should be within the rated range.  
Exceeding this range may cause the temperature to rise which might shorten the service life of this device or cause it to malfunction.
- ◆ This device is provided with ventilation holes for heat to escape. Prevent metal objects or other foreign matter from entering these ventilation holes as this may cause this device to malfunction. Do not block these ventilation holes or allow dirt and dust to stick to these holes. Temperature buildup or insulation failure might shorten the service life of this device or cause it to malfunction.
- ◆ Repeated tolerance tests on voltage, noise, surge, etc. may cause this device to deteriorate.
- ◆ Never remodel this device or use it a prohibited manner.
- ◆ To ensure safe and proper use of this device, and to maintain its reliability, observe the precautions described in this manual.
- ◆ Do not operate the keys on the front panel of this device with a hard or sharp-tipped object. Be sure to operate the keys with your fingertips.
- ◆ When cleaning this device, do not use paint thinner or other solvents. Wipe gently with a soft, dry cloth.
- ◆ It takes 30 minutes to display the correct temperature after applying power to the digital controller. (Therefore, turn the power on more than 30 minutes prior to the operation.)

## Check before use

This device has been fully checked for quality assurance before shipment from the factory. However, you are requested to make sure that there are no errors, damages or shortages in the delivered items by confirming the model code, external appearance of the device and the number of accessories.

### Confirmation of model codes

Referring to the table below check the model codes affixed to the case of the product to check if the respective codes indicate what was specified when you ordered the product.

### Checking accessories

Make sure that your product package has all of the following items

#### Standard accessories

- (1) Instruction Manual (A3 size paper ×4)
- (2) Mounting fixture (w/ 2 screws)
- (3) Terminal cover
- (4) Unit decal

#### Optional accessories

- (1) Current transformer (CT) for heater break alarm (when the heater break alarm option is selected)
- (2) Terminal resistor (when the RS-485 communication option is selected)

### Options (sold separately)

The following table shows the options available for this product.

Model Name	Model No.	Specification
Infrared Communication Adapter	S5004	USB 1.1
Shunt resistor	QCS002	250Ω±0.1%
Relay Unit	AP2MC	Converts open collector output to 2-point contact.
SV No. Selector	KA251	BIN code, switchable between SV1 to SV10

Setup tool "Parameter Assistant" /USB driver can be downloadable FREE from the Shimaden website shown as below.

<http://www.shimaden.co.jp/english/support/index.html>

## ■ 1-input specification

Item	Code	Specification		
1. Series	SR23-	Multi-function controller, DIN 96 x 96 mm		
2. Basic functions	SS	Universal-input, 1-input/1-output control, 3 event outputs		
	SD	Universal-input, 1-input/2-output control, 3 event outputs		
3. Control Output 1	Y	Contact 1c, Contact rating: 240 V AC, 2.5 A/resistive load, 1A/ inductive load		
	I	Current 4 to 20 mA DC, Load resistance: 600Ω max.		
	P	SSR drive voltage 12 V±1.5 V DC, Load current: 30 mA max.		
	V	Voltage 0 to 10 V DC, Load current: 2 mA max.		
4. Control Output 2 N- selected when basic function SS is used	N-	None		
	Y-	Contact 1c, Contact rating: 240 V AC 2.5 A/resistive load, 1A/ inductive load		
	I-	Current 4 to 20 mA DC, Load resistance: 600Ω max.		
	P-	SSR drive voltage 12 V±1.5 V DC, Load current: 30 mA max.		
	V-	Voltage 0 to 10 V DC, Load current: 2 mA max.		
5. Remote Input/ Heater break alarm (for single-phase) *1	Standard	06	0 to 10 V DC, Input resistance: Approx.500 kΩ	Not insulated
		04	4 to 20 mA DC, Input resistance: 250Ω	
		05	1 to 5 V DC, Input resistance: Approx.500 kΩ	Insulated
		14	4 to 20 mA DC, Input resistance: 250Ω	
	15	1 to 5 V DC, Input resistance: Approx.500 kΩ		
	16	0 to 10 V DC, Input resistance: Approx.500 kΩ		
		31	Heater break alarm (heater current 30 A, CT provided)	Selectable only when Control Output 1 or 2 is Y or P
		32	Heater break alarm (heater current 50 A, CT provided)	
6. Analog Output 1		0	Without	
		3	0 to 10 mV DC, Output resistance: 10Ω	
		4	4 to 20 mA DC, Load resistance: 300Ω max.	
		6	0 to 10 V DC, Load current: 2 mA max.	
7. Analog Output 2/Sensor Power Supply		0	Without	
		3	0 to 10 mV DC, Output resistance: 10Ω	
		4	4 to 20 mA DC, Load resistance: 300Ω max.	
		6	0 to 10 V DC, Load current: 2 mA max.	
		8	Sensor power supply 24 V DC 25mA	
8. External I/O control signals (DI/DO) *2	Standard	0	4 DI, 5 DO	
		1	10 DI, 9 DO	
		2	10 DI, 13 DO	
9. Communication interface		0	Without	SHIMADEN protocol/MODBUS communication protocol
		3	RS-485 (not insulated)	
		5	RS-485	
		7	RS-232C	
10. Remarks		0	Standard firmware	
		1-9 A-Z	Customized firmware	

\*1 When the 2-output specification is used, either of Control Output 1 or Control Output 2 is used as the heater break alarm.

\*2 Ten DI points (code 1 or 2) are required for switching the SV No. by DI.

# Contents

<b>1</b>	<b>INSTALLATION &amp; WIRING</b> .....	<b>1</b>
1-1	Installation Site .....	1
1-2	External Dimensions and Panel Cutout .....	1
1-3	Mounting .....	2
1-4	Current Transformer (CT) for Heater Break Alarm .....	3
1-5	Rear Terminal Arrangement Diagrams .....	4
1-6	Wiring .....	6
<b>2</b>	<b>NAMES &amp; FUNCTIONS OF PARTS ON FRONT PANEL</b> .....	<b>7</b>
<b>3</b>	<b>BASIC OPERATIONS</b> .....	<b>11</b>
3-1	Power ON .....	11
3-2	Switching LCD Screen Display and Moving the Cursor .....	12
	(1) Switching the screen display .....	12
3-3	Changing and Registering Data .....	13
	(1) Entering numerical values .....	13
	(2) Selecting setup items .....	14
<b>4</b>	<b>CONTROL FUNCTION BLOCK DIAGRAMS</b> .....	<b>15</b>
4-1	1-input, 1-output/2-output .....	15
<b>5</b>	<b>SETUP</b> .....	<b>17</b>
5-1	Parameter Setup Procedure .....	17
<b>6</b>	<b>OUTPUT SPECIFICATION &amp; KEY LOCK</b> .....	<b>19</b>
6-1	Confirming the Output Specification .....	19
6-2	Releasing the Key Lock .....	20
	(1) Key lock screen display .....	20
	(2) Releasing the key lock .....	20
<b>7</b>	<b>I/O SETTINGS, INFRARED COMMUNICATION</b> .....	<b>21</b>
7-1	Output Specifications (2-output specification).....	21
7-2	Infrared Communication .....	21
7-3	Measuring Range .....	22
	(1) Range setting .....	22

---

	(2) Range scaling.....	22
7-4	Unit.....	26
7-5	Decimal Point Position.....	26
	(1) Decimal point position .....	26
	(2) Switching the lowest digit past the decimal point .....	27
7-6	Cold Junction Compensation.....	28
	(1) Thermocouple cold junction compensation .....	28
<b>8</b>	<b>I/O AUXILIARY SETTINGS.....</b>	<b>29</b>
8-1	PV Compensation Value .....	29
	(1) PV bias .....	29
	(2) PV filter .....	29
	(3) PV slope .....	29
8-2	Square Root Extraction Operation.....	30
	(1) Enabling the square root extraction operation.....	30
	(2) Low cut .....	30
8-3	Control Output .....	31
	(1) Action characteristics.....	31
	(2) Output at standby .....	31
	(3) Output at error .....	32
	(4) Proportional cycle time .....	32
	(5) Setting output 2 .....	32
	(6) Rate-of-change limiter .....	33
8-4	Ten-Segment Linearizer Approximation .....	33
	(1) Enabling ten-segment linearizer approximation .....	33
	(2) Setting input points.....	33
8-5	Compensating Control Output/Analog Output .....	36
<b>9</b>	<b>SV VALUE &amp; REMOTE SV VALUE .....</b>	<b>38</b>
9-1	Setting the SV Value .....	38
	(1) SV limiter .....	38
	(2) Set value (SV) .....	38
9-2	Setting the Remote SV Value.....	39
	(1) Monitoring the remote SV.....	39
	(2) Remote tracking .....	39
	(3) Remote mode .....	40
9-3	Setting the Remote SV Compensation Value.....	41
	(1) Remote ratio .....	41
	(2) Remote bias .....	42
	(3) Remote filter .....	42
	(4) Remote scale.....	43
9-4	Setting the Remote PID No. and Square Root Extraction Operation.....	44



	(1) Setting the remote PID No. ....	44
	(2) Enabling remote square root extraction operation function.....	44
	(3) Low cut.....	45
9-5	Setting the Ramp .....	45
	(1) Ramp value .....	45
	(2) Ramp unit time .....	45
	(3) Ramp ratio .....	46
	(4) Executing ramp control .....	46
<b>10</b>	<b>PID SETTING.....</b>	<b>48</b>
10-1	Proportional Band (P) .....	48
10-2	Integral Time (I) .....	48
10-3	Derivative time (D).....	49
10-4	Manual Reset (MR) .....	49
10-5	Action Hysteresis (DF).....	50
10-6	Dead Band (DB) .....	50
10-7	Set Value Function (SF) .....	52
10-8	Output Limit Value (OUT1L to OUT2H) .....	53
10-9	Zone PID .....	54
	(1) Selecting Zone PID .....	54
	(2) Zone hysteresis.....	55
	(3) PID zone .....	55
10-10	Auto Tuning Point.....	56
<b>11</b>	<b>EVENT &amp; DO SETTING.....</b>	<b>58</b>
11-1	Monitor Screens .....	58
	(1) DO monitor.....	58
	(2) Logic monitor .....	58
11-2	EVENT/DO Action .....	58
	(1) Output characteristics .....	60
	(2) Hysteresis .....	61
	(3) Delay time .....	61
	(4) Inhibit action.....	62
	(5) Event action at inhibit.....	62
11-3	Event Logic Operations .....	63
	(1) Logic operation mode (Log MD) .....	63
	(2) Assigning logic operation input (SRC1, SRC2).....	63
	(3) Logic operation input logic (Gate1, Gate2) .....	64
11-4	Timers/Counters .....	64
	(1) Timer time .....	64
	(2) Counter .....	65
	(3) Assigning input (SRC).....	65

---

(4) Mode (Log MD).....	65
<b>12 OPTION (DI, AO, HB, COM) SETTING .....</b>	<b>66</b>
12-1 DI.....	66
(1) DI monitor screen .....	66
(2) Selecting DI action.....	66
12-2 Analog Output .....	68
(1) Analog output type.....	68
(2) Scaling analog output.....	68
12-3 Setting the Heater Break/Heater Loop Alarms .....	69
(1) Connecting the current transformer (CT).....	69
(2) Heater current monitor.....	69
(3) Heater Break Alarm current (HBA) .....	70
(4) Heater Loop Alarm current (HLA).....	70
(5) Heater Break/Heater Loop Alarm mode (HBM).....	70
(6) Heater Break detection selection (HB) .....	71
12-4 Communication .....	72
(1) Setting communication .....	72
(2) Communication mode (COM).....	73
<b>13 KEY LOCK SETTING.....</b>	<b>74</b>
13-1 Setting Key Lock.....	74
(1) Displaying the key lock screen .....	74
(2) Key lock .....	74
<b>14 MONITORING, EXECUTING &amp; STOPPING OPERATION.....</b>	<b>76</b>
14-1 Flow of Basic Screen.....	76
(1) 1-input specification.....	76
14-2 Operations in Basic Screen .....	77
(1) Switching the SV No.....	77
(2) Output monitor screen.....	77
<b>15 OPERATIONS DURING CONTROL.....</b>	<b>78</b>
15-1 Monitoring Control .....	78
(1) Basic screen .....	78
(2) Output value display .....	78
15-2 Switching the Execution SV No. ....	79
15-3 Setting the Execution SV No. ....	79
15-4 Externally Switching the SV No. ....	80
15-5 Auto Tuning .....	81
(1) Executing and Stopping Auto Tuning .....	81

---

	(2) Selecting the PID tuning mode .....	82
15-6	Self Tuning .....	82
15-7	Setting Control Output .....	83
	(1) Switching auto/manual of Control Output.....	83
	(2) Output value.....	83
	(3) MAN key operations.....	84
15-8	Control Standby (STBY) .....	85
15-9	Pausing/Resuming Ramp Control (RAMP).....	86
15-10	Tuning Functions .....	87
	15-10-1 Auto tuning (AT) .....	87
	15-10-2 Self tuning.....	89
	(1) Self tuning: by step response (St).....	89
	(2) Self tuning: by hunting suppression (Hu) .....	91
<b>16</b>	<b>ERROR DISPLAYS.....</b>	<b>94</b>
16-1	Operation Check Abnormalities at Power ON.....	94
16-2	PV Input Abnormalities .....	94
16-3	REM Input Abnormalities .....	95
16-4	Heater Current Abnormalities (option) .....	95
<b>17</b>	<b>LIST OF PARAMETERS.....</b>	<b>96</b>
17-1	Basic Screen Group (group 0).....	96
17-2	Execution Screen Group (group 1) .....	96
17-3	SV Setup Screen Group (group 2).....	97
17-4	PID Screen Group (group 3).....	98
17-5	EVENT/DO Screen Group (group 4) .....	99
17-6	DI/Options Screen Group (group 5).....	101
17-7	Communication (group 5) .....	102
17-8	Control Output Screen Group (group 6) .....	103
17-9	Unit/Range Screen Group (group 7).....	104
17-10	Lock, etc Screen Group (group 8) .....	105
<b>18</b>	<b>PARAMETER SETUP RECORD SHEETS.....</b>	<b>106</b>
18-1	Product Model Code.....	106
18-2	SV Parameters .....	106
18-3	PID Parameters .....	107
18-4	EVENT/DO Parameters.....	108
18-5	DI/Options Parameters .....	109
18-6	Control Output Parameters.....	109
18-7	Unit Measuring Range Parameters .....	110

---

18-8	Lock, etc. Parameters.....	111
<b>19</b>	<b>SPECIFICATIONS .....</b>	<b>112</b>
19-1	Display.....	112
19-2	Setting .....	113
19-3	Input .....	114
19-4	Control.....	115
19-5	Event Output .....	116
19-6	External Control Output (DO) .....	117
19-7	External Control Input (DI).....	117
19-8	Logic Operation Functions.....	118
19-9	Heater Break Alarm (option).....	118
19-10	Analog Output (option) .....	119
19-11	Sensor Power Supply (option).....	119
19-12	Communication (option) .....	120
19-13	Infrared Communication .....	121
19-14	General Specifications.....	121

This page left intentionally blank.

# LCD Flow Chart

The following figure shows how to progress through the LCD screen hierarchy on this device.

- Standard screen Screens that are always displayed
- Non-standard screen Screens that are displayed depending on options/setup values.

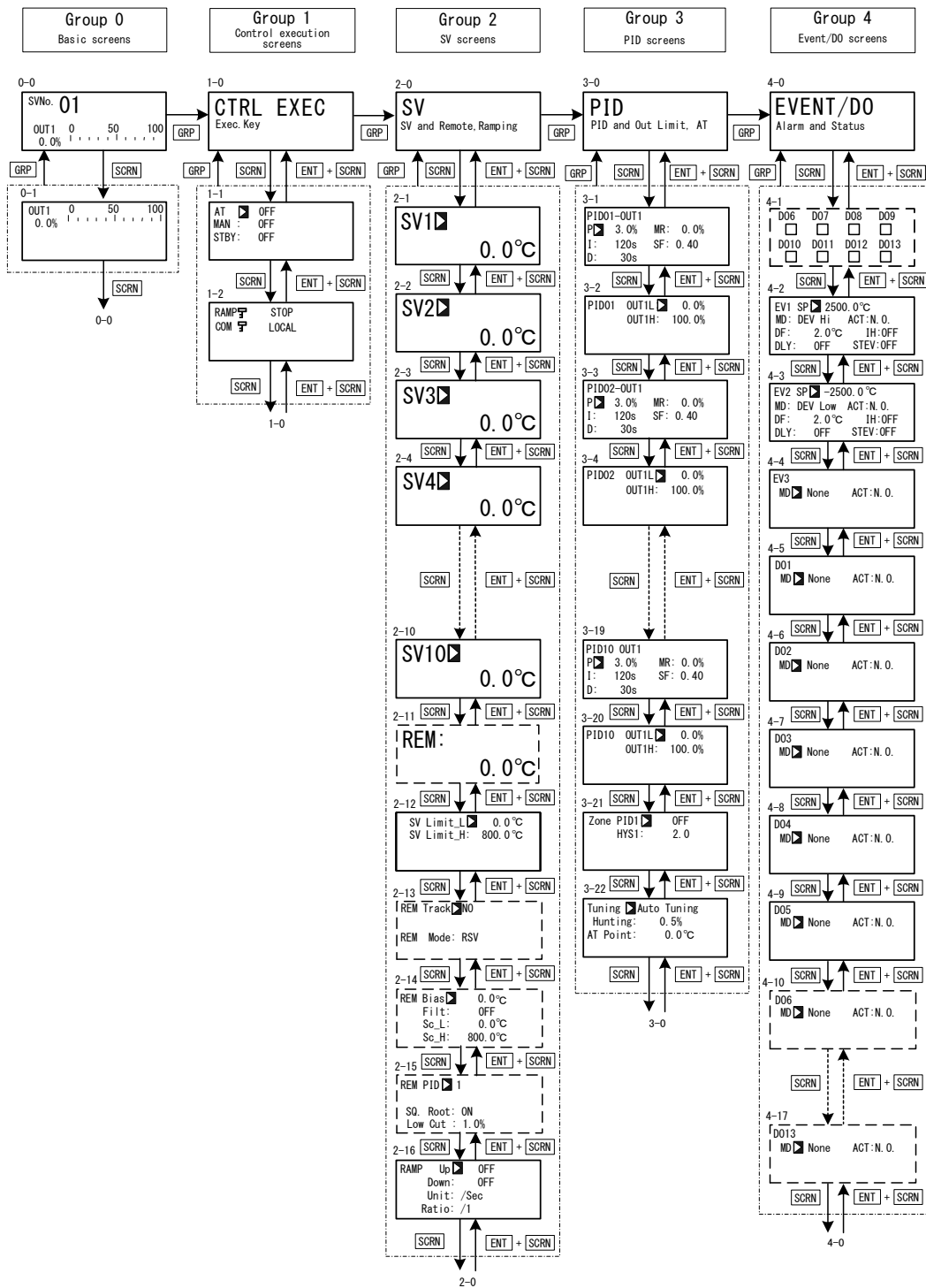

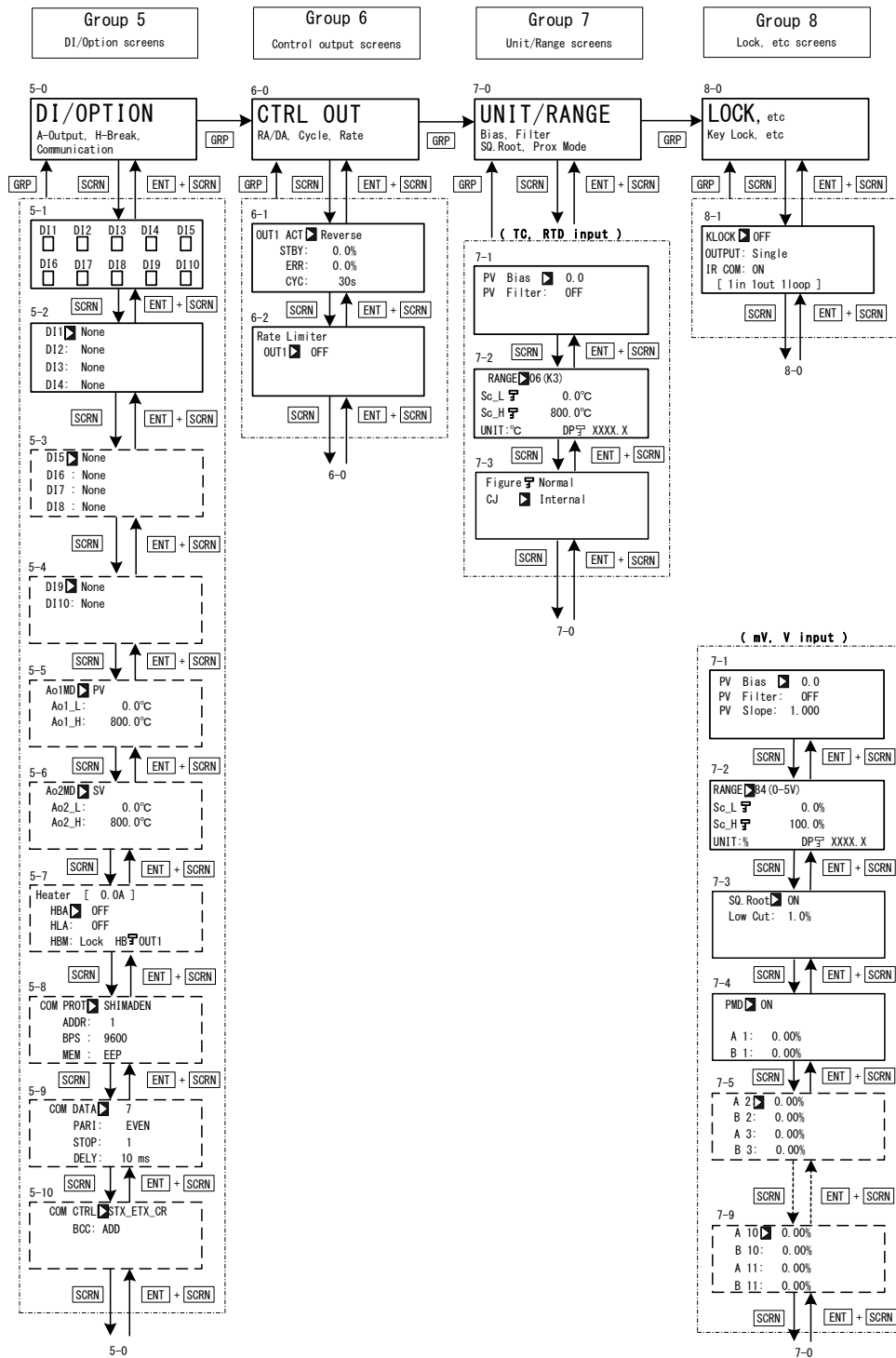

When the **DISP** key is pressed at a screen other than the 0-0 basic screen, the 0-0 basic screen is returned to.

This page left intentionally blank.



# 1 INSTALLATION & WIRING

## 1-1 Installation Site



### Caution

Do not use this device in the following sites. Doing so might result in malfunction or damage to this device and in some cases cause fire and/or dangerous situations.

- ◆ Locations that are filled with or generate inflammable gas, corrosive gas, dirt and dust, smoke, etc.
- ◆ Locations that are subject to water droplets, direct sunlight or strong radiated heat from other equipment
- ◆ Locations where the ambient temperature falls below  $-10^{\circ}\text{C}$  or rises above  $50^{\circ}\text{C}$
- ◆ Locations where dew condensation forms and the humidity reaches 90% or more
- ◆ Near equipment that generates high-frequency noise
- ◆ Near heavy current circuits or locations likely to be subject to inductive interference
- ◆ Locations subject to strong vibration and impact
- ◆ Locations exceeding an elevation of 2000 m

## 1-2 External Dimensions and Panel Cutout

### External dimensions

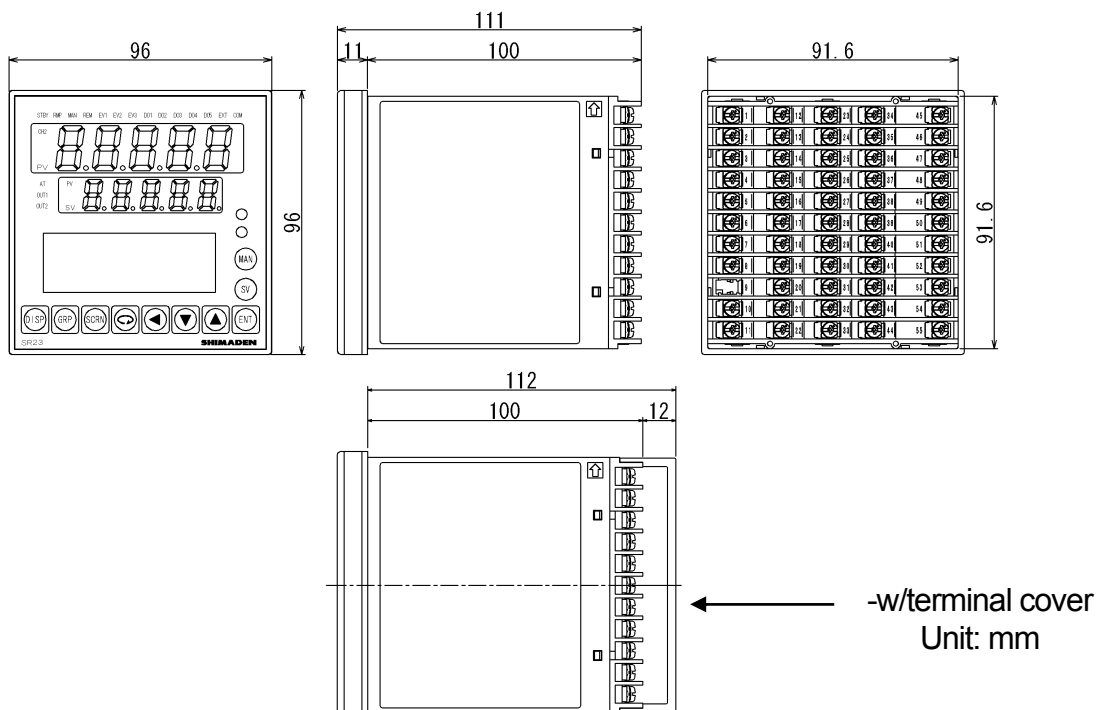

## Panel cutout

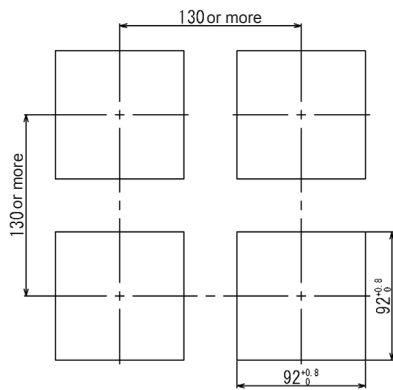

Unit: mm

## 1-3 Mounting



### Caution

To ensure safety and maintain the functions of this device, do not disassemble this device.  
If this device must be disassembled for replacement or repair, contact your dealer.

Follow the procedure below to mount this device on a panel.

1. Drill mounting holes referring to the panel cutout dimensions described in the previous section.  
The applicable thickness of the mounting panel is 1.0 to 8.0 mm.
2. Press this device into the panel from the front of the panel.
3. Insert the mounting fixtures at the top and bottom of this device, and tighten the screws from behind to fasten the device in place.
4. Over-tightening the screws may deform or damage the device housing.  
Take care not to tighten the screws too tight.
5. After completing wiring after installation, attach the terminal cover.

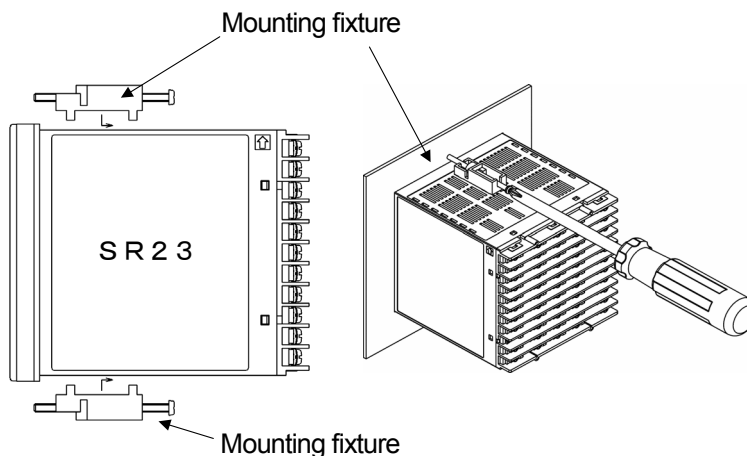

## 1-4 Current Transformer (CT) for Heater Break Alarm

The CT can be used when the heater break alarm (option) is selected in the product specifications.

Either of the following CT is provided.

### ■ For 0 to 30A (CTL-6-S)

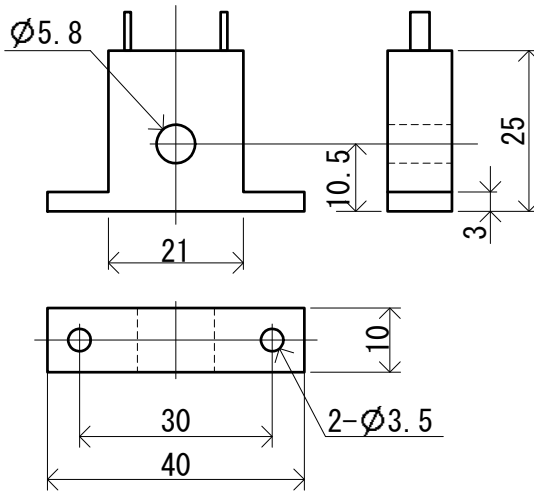

Unit: mm

### ■ For 0 to 50A (CTL-12-S36-8)

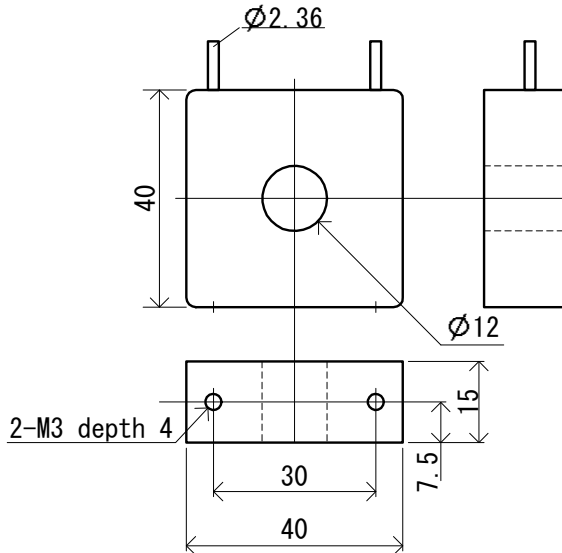

Unit: mm

# 1-5 Rear Terminal Arrangement Diagrams

## ■ 1-input model

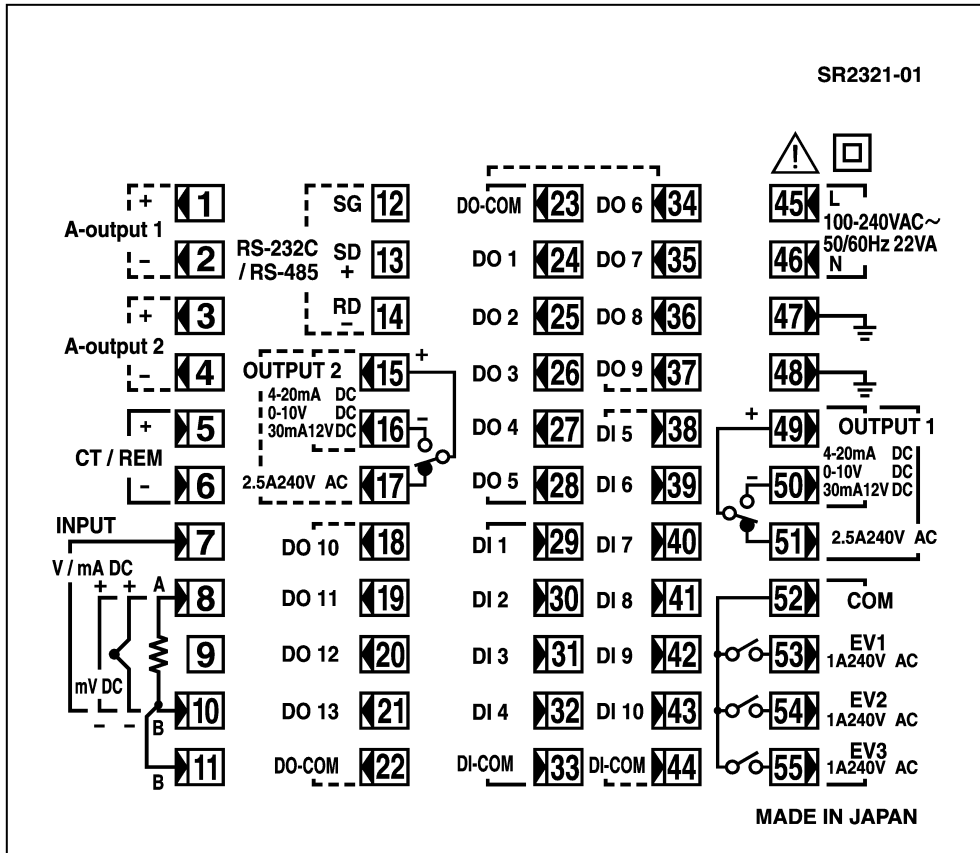

Terminal No.	Symbol	Description	
1 2	+ -	Analog output 1 (option)	
3 4	+ -	Analog output 2 or Sensor power supply (option)	
5 6	+ -	Remote input/ Heater break alarm * CT input (option)	
8 10	+ -	mV, Thermocouple input	Input
8 10 11	A B B	RTD input	
7 10	+ -	V, mA input	
45 46	L N	Power supply	
47 48		Grounding (internal shorting across terminals)	
49 50 51	COM + NO - NC	Control output 1	
52 53 54 55	COM EV1 EV2 EV3	Event output	
23 24 25 26 27 28	COM DO1 DO2 DO3 DO4 DO5	External control output DO (standard feature)	Darlington output
			Open collector output
29 30 31 32 33	DI1 DI2 DI3 DI4 COM	External control output D1 (standard feature)	

Terminal No.	Symbol	Description
34 35 36 37	DO6 DO7 DO8 DO9	External control output DO Open collector output (option)
38 39 40 41 42 43 44	DI5 DI6 DI7 DI8 DI9 DI10 COM	External input DI5 to DI10 (option)
12 13 14	SG SD+ RD-	Communication function (option)
15 16 17	COM + NO- NC	Control output 2 (option)
18 19 20 21 22	DO10 DO11 DO12 DO13 DO COM	External control output DO10 to DO13 Open collector output (option)

A receiving resistor of 1/2W 250Ω 0.1% is attached across input terminals (7-10) for use for the 0 to 20 mA, and 4 to 20mA inputs.

\* Selectable from remote inputs (including optional) or Heter break alarm (optional).

## 1-6 Wiring



### Caution

- ◆ To prevent electric shock, always turn off and disconnect this device from the power supply before starting wiring.
- ◆ Do not touch wired terminals or charged parts with your hands while the power is supplied.

Pay attention to the following points when performing wiring:

- ◆ Check that the wiring is free from mistakes according to "1-5 Rear Terminal Arrangement Diagrams."
- ◆ Use crimped terminals that accommodate an M3 screw and that have a width of 6.2 mm or less.
- ◆ For thermocouple input, use a compensation wire compatible with the type of thermocouple.
- ◆ For RTD input, the resistance of a single lead wire must be 10Ω or less and the three wires must have the same resistance.
- ◆ The input signal lead must not be passed along the same conduit or duct as that for high-voltage power lines.
- ◆ Shield wiring (single point grounding) is effective against static induction noise.
- ◆ Short interval twisted pair wiring is effective against electromagnetic induction noise.
- ◆ When wiring, use wire or cable (minimum 1 mm<sup>2</sup> cross-sectional area) of 600 V grade PVC insulated wire or equivalent wire having the same rating.
- ◆ For wiring the ground, ground the ground terminal with the earth resistance at less than 100Ω and with wire 2 mm<sup>2</sup> or thicker.
- ◆ Two earth terminals are provided, each connected internally. One is for the ground connection, and the other is for connecting the shield of the signal lead. Do not use the earth terminals for crossover wiring of the power system ground lead.
- ◆ If this device is considered as being susceptible to noise caused by the power supply, attach a noise filter to prevent abnormal functioning.  
Install a noise filter onto a grounded panel, and make the wire connecting the noise filter output and the power supply terminal on this controller as short as possible.

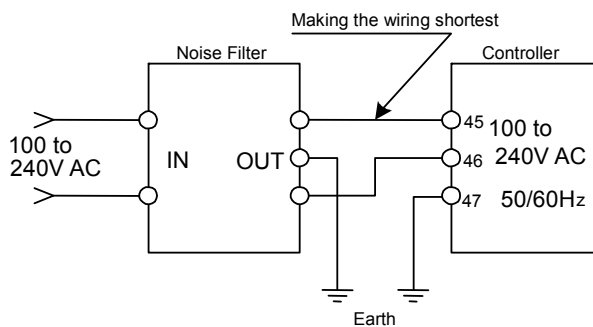

Recommended noise filter : RSEL-2003W from TDK

## 2 NAMES & FUNCTIONS OF PARTS ON FRONT PANEL

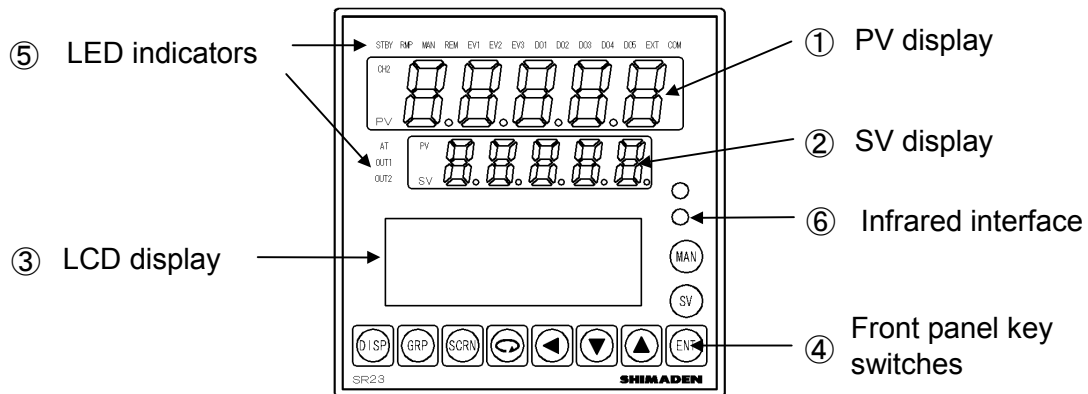

### ① PV display

Displays the measured value (PV value).

Displays an error message when an error (e.g. scale over) occurs.













### ② SV display

Displays the target set value (SV value).

### ③ LCD display (21 characters x 4 lines, max.)

SV No. display	Displays the current target setting value (SV) No..
Output (OUT) display	Displays the control output value by a numerical value and a bar graph as a percentage (%).
Screen title display	Displays the screen group title in the respective screen group top screen.
Setup parameter display	Displays the parameters that can be selected and displayed by front key operation.

#### ④ Front panel key switches

	(Display key)	Displays the basic screen.
	(Group key)	Changes the screen group. Or, returns to the screen group top screen.
	(Screen key)	Switches the parameter display screen in a screen group.
	(Parameter key)	Selects the parameter to set up or change. The parameter to be changed is indicated by the cursor (▶).
	(Shift key)	Moves the digit in set numerical values.
	(Down key)	Decrements parameters and numerical values during setup.
	(Up key)	Increments parameters and numerical values during setup.
	(Entry key)	Registers data or parameter numerical values.
	(SV key)	Switches the execution SV No. in the basic screen. In screens other than the basic screen, the execution SV No. can be switched when the display is switched to the basic screen.
	(Manual key)	Used for manual output (MAN). Switches to the output monitor screen whichever screen is displayed. With the output monitor displayed, you can use the   keys to switch to manual output.



## ⑤ LED indicators

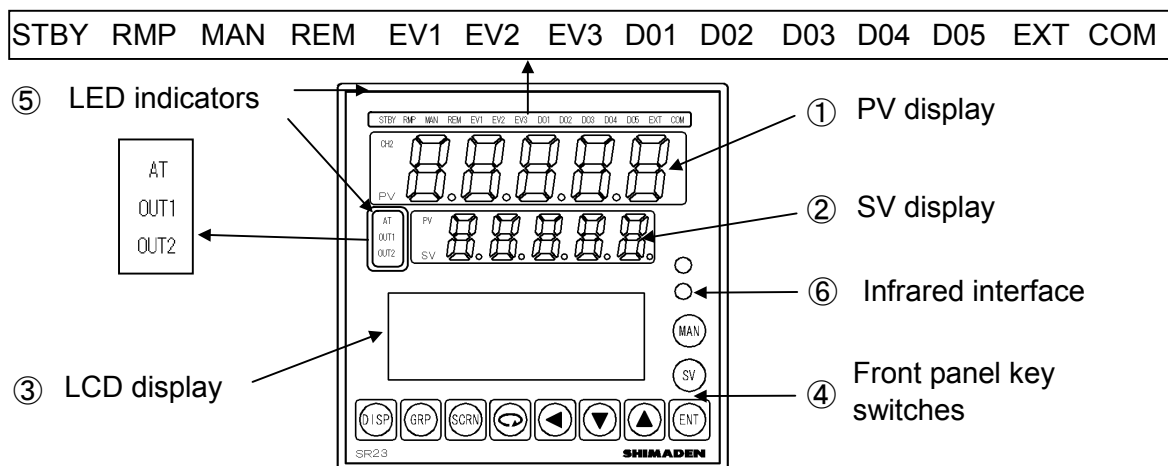

## ■ Status lamps

STBY	green	Blinks when output is set to standby (STBY=ON) by control execution/standby.
RMP	green	Blinks during execution of ramp control, and lights while ramp control is paused.
MAN	green	Blinks when control output is set to manual operation (MAN).
REM	green	Lights when remote setting (REM) is set in SV No. selection.
EV1	orange	Lights during EV1 action.
EV2	orange	Lights during EV2 action.
EV3	orange	Lights during EV3 action.
DO1	orange	Lights during DO1 action.
DO2	orange	Lights during DO2 action.
DO3	orange	Lights during DO3 action.
DO4	orange	Lights during DO4 action.
DO5	orange	Lights during DO5 action.
EXT	green	Lights when external switch setting (EXT) is set when multi-SV No. selection (SV select) is switched to.
COM	green	Lights when communication (COM) mode is selected.
AT	green	Blinks during execution of auto tuning or lights during holding of auto tuning.
OUT1	green	When control output is current or voltage output, the brightness of this lamp changes according to fluctuation of Control Output 1, and during contact or SSR drive voltage output, this lamp lights when Control Output 1 is ON and goes out when Control Output 1 is OFF.
OUT2	green	When control output is current or voltage output, the brightness of this lamp changes according to fluctuation of Control Output 2, and during contact or SSR drive voltage output, this lamp lights when Control Output 2 is ON and goes out when Control Output 2 is OFF.

This page left intentionally blank.

## 3 BASIC OPERATIONS

### 3-1 Power ON

When the power is turned ON, the basic screen is displayed after the initial screen is displayed on the LCD for about three seconds.

When the SR23 is powered ON for the first time, check on screen to make sure that this device is the one you ordered.

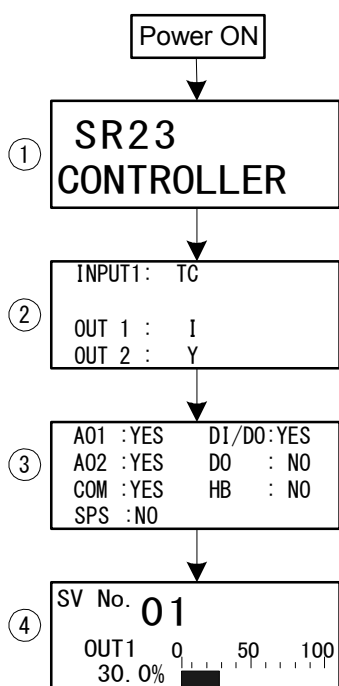

① The series name is displayed.

② The I/O type is displayed.

The figure shows a thermocouple (TC) set for Input 1, current (I) set for Output 1, and contact (Y) set for Output 2.

③ The installation status of option functions is displayed.

The figure shows that Analog Output 1, Analog Output 2 and the communication function are installed (YES), DI (10 points) and DO (9 points) are installed (YES), and DO 13 points and the heater break alarm are not installed (NO), and no SPS (sensor power supply) is not available (NO).

④ Basic screen (Monitor Group top screen)

The figure shows that OUT1 of SV No.1 is outputting at 30%.

The details displayed on screen vary according to specifications, or according to preset function specifications.

The basic screen is the "SV No., output value display screen."

For details on operations in the basic screen, see "14-1 Flow of Basic Screen."

*Note*

- ◆ The actually installed numbers for external DI or DO can be confirmed with the above ③ screen.

LCD Display		Actual numbers	
DI/DO	DO	DI	DO
NO	NO	4	5
YES	NO	10	9
YES	YES	10	13

## 3-2 Switching LCD Screen Display and Moving the Cursor

### (1) Switching the screen display

For details on moving between screens, see "LCD Flow Chart" in the preface.

The operation screens of this device are configured so that screens are displayed in order from the most frequently used screen in regular use.

The following shows an example of screens in the 1-input/1-output specification.

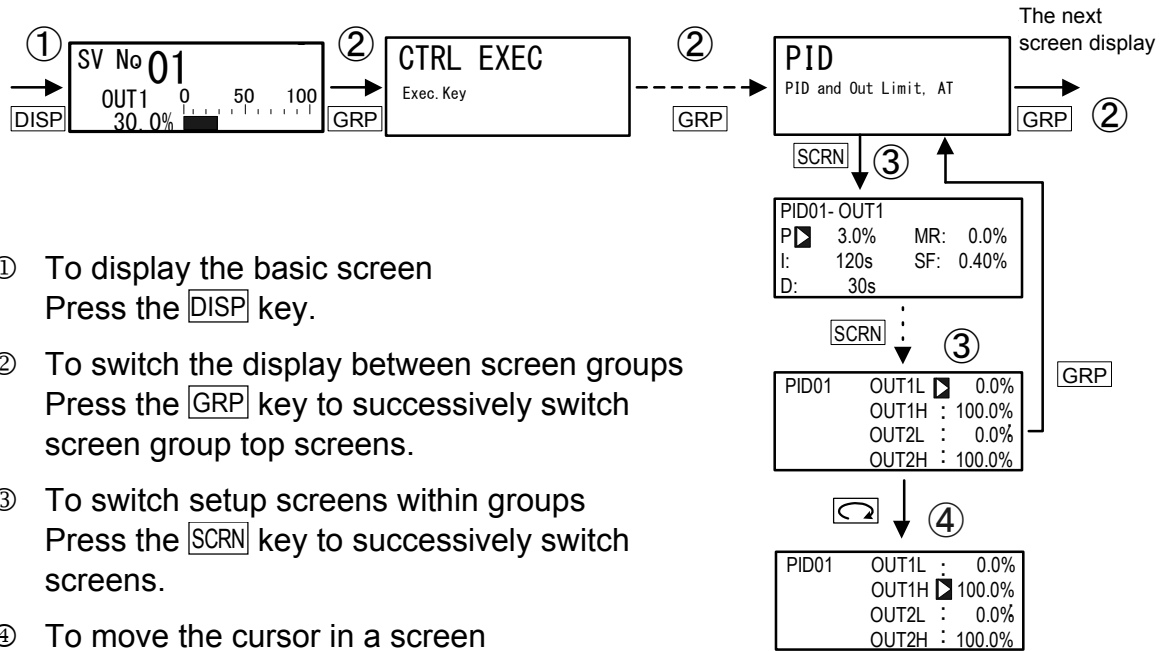









- ① To display the basic screen  
Press the **DISP** key.
- ② To switch the display between screen groups  
Press the **GRP** key to successively switch screen group top screens.
- ③ To switch setup screens within groups  
Press the **SCRN** key to successively switch screens.
- ④ To move the cursor in a screen  
Press the **Cursor key** (key with a square and a right-pointing arrow) (blinking) when there are two or more parameters in the same screen.
- ⑤ To display the top screen  
Press the **GRP** key in a respective parameter setup screen other than the basic screen group to switch to the top screen of a screen group.

### 3-3 Changing and Registering Data

Basically, set up and change parameters while confirming the LCD screen display.

#### (1) Entering numerical values

1. When there are two or more parameters, press the  key to move the cursor () to the parameter to be changed.
2. Press the  or ,  keys. The smallest digit of the numerical value blinks.
3. Press the  key again. Move the blinking section in the numerical value to the digit to be changed, and change the value using the  or  key.
4. Press the  key. The numerical value is fixed and registered, and stops blinking.



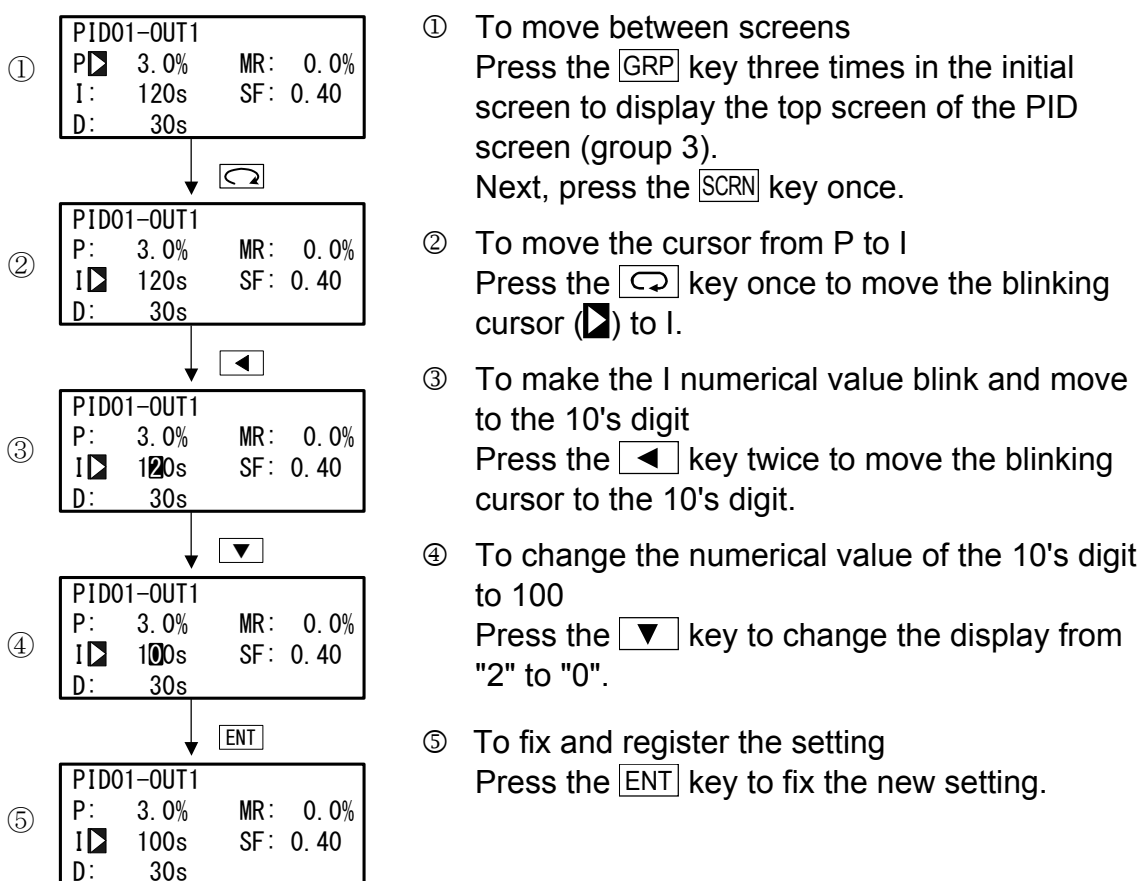

#### Changing a numerical value setting (example)

The following shows the procedure for changing the value of PID parameter I to 100 s.



## (2) Selecting setup items





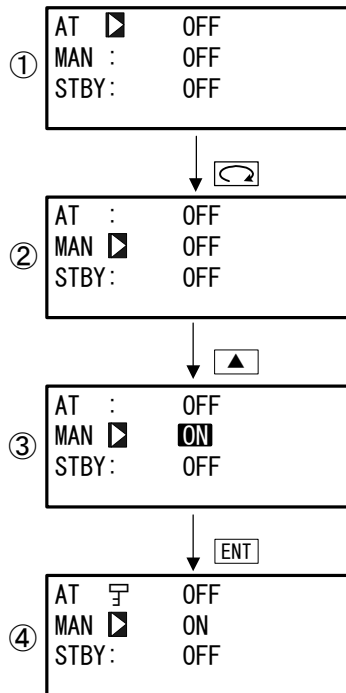

The settings of parameters marked by a  key mark cannot be changed.

1. When there are two or more parameters, press the  key to move the cursor () to the parameter to be changed.
2. Change the parameter settings by the  or  key, check the setting, and press the  key to fix and register settings. The character stops blinking.

### ■Selecting a parameter (example)

The following shows the procedure for changing control output to manual.



- ① To move between screens  
Press the  key once in the initial screen to display the top screen of the execution screen (group 1).  
Next, press the  key once.
- ② To move the cursor from AT to MAN  
Press the  key once to move the blinking cursor () to MAN.
- ③ To change the MAN setting from OFF to ON  
Press the  key to change the display from OFF to ON.
- ④ To fix and register the setting  
Press the  key to fix the new setting.  
In this case, the key mark is displayed as AT can no longer be operated.

# 4 CONTROL FUNCTION BLOCK DIAGRAMS

## 4-1 1-input, 1-output/2-output

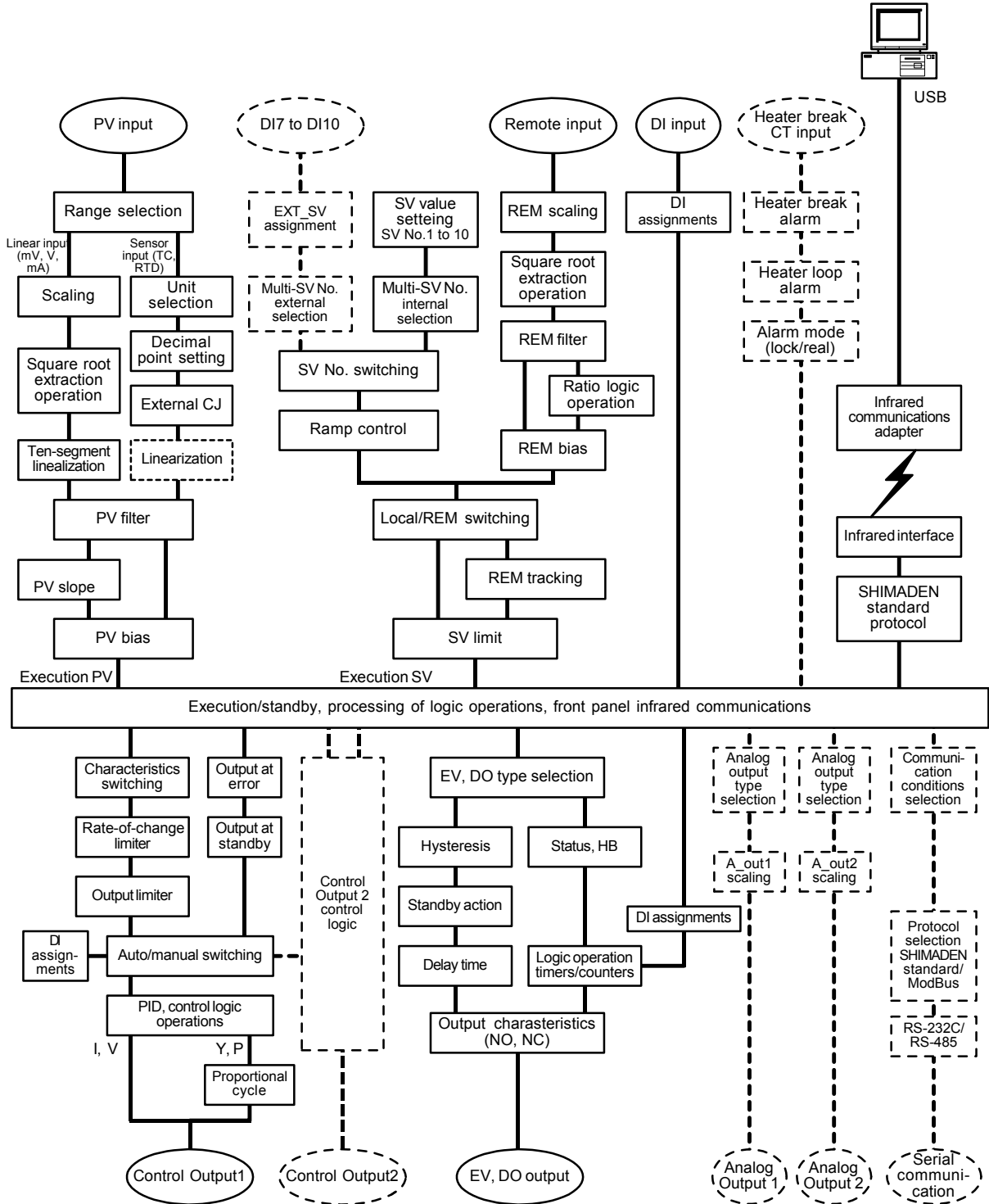

This page left intentionally blank.



## 5 SETUP

### 5-1 Parameter Setup Procedure

Follow the procedure below to set up this device or change device settings when you use this device for the first time, change the operation parameters during use, or the control target device has been changed, for example.

---

#### Caution

With some operations, when you initialize this device, all parameter settings return to their factory defaults.  
Before you initialize this device, note down and retain settings as required.

---

It is assumed that experienced personnel familiar with basic operation of this device will set up this device.

Users other than device manufacturers should thoroughly familiarize themselves with the functions to be used before they start to operate or set up this device.

Basic operations and setup of this device are described in detail from Chapter 6 onwards by each screen group.

Some screens and parameters are not displayed when option functions are not added on or when option functions are not selected.

For an overview of operation screens and how to move between screens, see "LCD Flow Chart" in the preface. For an overview of setup parameters, see "17 List of Parameters."

Set up parameters in the order shown below.

1. Confirm the Output Specification and Release the Key Lock.  
Perform this as necessary.  
For details, see "Chapter 6."
2. I/O Settings.  
For details, see "Chapter 7."
3. I/O Auxiliary Settings.  
For details, see "Chapter 8."
4. Set up the SV Value and Remove SV Value.  
For details, see "Chapter 9."
5. PID Settings.  
For details, see "Chapter 10."
6. EVENT/DO Settings.  
For details, see "Chapter 11."
7. Option (DI, AO, HB, COM) Settings.  
For details, see "Chapter 12."

**8. Key Lock Setting.**

After parameters including option functions are set or changed, set the key lock as necessary to prevent inadvertent operation.

For details, see "Chapter 13."

**9. Monitoring, Executing & Stopping operation.**

For details, see "Chapter 14."

**10. Operations During Control.**

For details, see "Chapter 15."

## 6 OUTPUT SPECIFICATION & KEY LOCK

Perform the following as necessary.

### 6-1 Confirming the Output Specification

The current output specification is displayed at the bottom row of the key lock, number of outputs setting screen (No.8-1).

8-1

KLOCK	OFF
OUTPUT:	Single
IR COM:	ON
[ 1in 1out 1loop ]	

1in 1out 1loop: 1-output controller

1in 2out 1loop: 2-output controller

## 6-2 Releasing the Key Lock

### (1) Key lock screen display

To call up the LOCK, etc. screen group (group 8) from the basic screen, press the **[GRP]** key.

Press the **[SCRN]** key in the LOCK, etc. screen group to switch to the screens for making and changing setups.

Select parameters in screens by pressing the **[↻]** key.

Set parameters by pressing the **[◀]**, **[▼]** or **[▲]** key, and press the **[ENT]** key to fix and register settings.

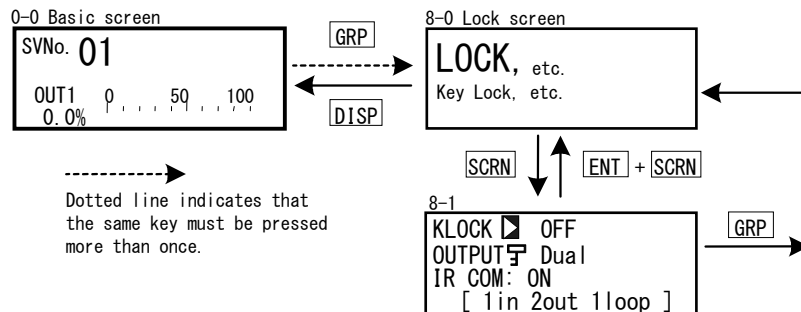

### (2) Releasing the key lock

When the key lock is applied, the **[🔒]** (key mark) is displayed at the relevant parameter on the LCD screen indicating that the parameter cannot be set or its settings changed. The following shows the procedure for releasing the key lock.

8-1		
KLOCK <b>[🔒]</b> OFF	Setting range	OFF, LOCK1, LOCK2, LOCK3
Tuning: Auto Tuning	Initial value	OFF
OUTPUT: Single		
[ 1in 1out 1loop ]		

- OFF Releases the key lock
- LOCK1 Locks parameters other than SV related, AT, MAN, or EVENT/ DO action point
- LOCK2 Locks parameters other than SV related parameters
- LOCK3 Locks all parameters (excluding the key lock parameter itself)

For details on parameters that are locked, see "17 List of Parameters."

## 7 I/O SETTINGS, INFRARED COMMUNICATION

### 7-1 Output Specifications (2-output specification)

At this item, select either 1-output action (Single) or 2-output action (Dual).  
When action is set to Single, control output becomes the output of OUT1 only.

Select the output mode after setting control action to the standby mode (STBY: ON).  
For details on control standby operation, see "15-8 Control Standby (STBY)."

8-1		Setting range	Single, Dual
	KLOCK: OFF	Initial value	Single
	OUTPUT: Single		
	IR COM: ON		
	[ 1in 1out 1loop ]		

- Single 1-output control action  
Only OUT1 is used for control output.
- Dual 2-output control action  
OUT1 and OUT2 are used for control output.

#### Displaying the current operation mode

The current operation mode is displayed at the bottom line of the key lock, tuning mode (display only) and number of outputs setup screen (No. 8-1).

- 1in 1out 1loop 1-output controller  
1in 2out 1loop 2-output controller

### 7-2 Infrared Communication

Allow the infrared communication using S5004 (Infrared Communication Adapter, selling separately). IR COM should be ON before the instrument parameters are set via infrared communication.

Parameter Assistant Software is also used for this communication. For details, see "Parameter Assistant Instruction Manual" which can be accessed from its Help menu.

8-1		Setting range	ON, OFF
	KLOCK : OFF	Initial value	ON
	OUTPUT: Dual		
	IR COM: ON		
	[ 1in 2out 1loop ]		

- ON Infrared communication by S5004 is available.  
OFF Infrared communication by S5004 is not available.

### 7-3 Measuring Range

Before performing setup or changes to the setup, set control action to the standby mode (STBY: ON).

For details on control standby operation, see "15-8 Control Standby (STBY)."

#### (1) Range setting

Set the code No. to RANGE referring the Measuring Range Code Table below.

7-2

RANGE	06 (K3)
Sc_L	0.0°C
Sc_H	800.0°C
UNIT:°C	DP XXXX.X

Setting range 01 to 19, 31 to 58, 71 to 77, 81 to 87

Initial value 06 (K3)  
K T/C 0.0 to 800°C

When the current input is 4 to 20 mA or 0 to 20 mA, select RANGE No.85 (1 to 5V) or 84 (0 to 5V), and attach a receiving resistor of 250Ω 0.1% across input terminals for use.

When the range is changed in the above screen, the following confirmation message will be displayed.

Press the  key to select YES, and press the  key to apply the setting.

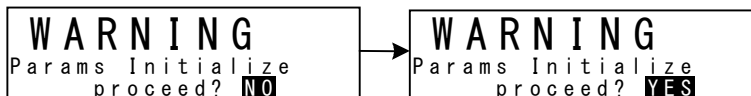

### Caution

- ◆ When the range is changed, the above warning message will be displayed, and parameters will be initialized.  
For details on parameters that are initialized, see "17 List of Parameters"

#### (2) Range scaling

Set the measuring range (scaling) when the selection range is voltage input and current input (corresponding to code Nos.71 to 77, 81 to 87).

Before performing setup or changes to the setup, set control action to the standby mode (STBY: ON).

For details on control standby operation, see "15-8 Control Standby (STBY)."

The key mark is displayed and this item cannot be set in the case of RTD or thermocouple input.

Reverse scaling is not possible.

The maximum span is  $(Sc\_H - Sc\_L) \leq 30000$ .

When an  $Sc\_L$  is set that causes the span to exceed 30000, a value that does not exceed span is automatically set to  $Sc\_H$ .

7-2

RANGE: 86 (0 ~ 10 V)	
Sc_L	0.0 %
Sc_H:	100.0 %
UNIT: %	DP: XXXX.X

Settable range	-19999 to 30000 digit
Measuring range	Minimum span: 10 digit Maximum span: 30000 digit Any setting within the above ranges is possible. (Note that $Sc\_L < Sc\_H$ )
Initial value	Sc_L: 0 digit, Sc_H: 1000 digit

When scaling is changed in the above screen, the following confirmation message will be displayed.

Press the  key to select YES, and press the  key to apply the setting. The range will be changed.

<b>WARNING</b> Params Initialize proceed? <b>NO</b>	→	<b>WARNING</b> Params Initialize proceed? <b>YES</b>
---	---	--

## Caution

- ◆ When the range is scaled, the above warning message will be displayed, and parameters will be initialized. For details on parameters that are initialized, see "17 List of Parameters."

### ■Measuring Range Code Table

Input Type	Sensor Type	Code	Symbol	Measuring range	Measuring range	
Universal Input	Thermo couple	B *1	01	B	0.0 to 1800.0 °C	0 to 3300 °F
		R	02	R	0.0 to 1700.0 °C	0 to 3100 °F
		S	03	S	0.0 to 1700.0 °C	0 to 3100 °F
		K	04	K1	-100.0 to 400.0 °C	-150.0 to 750.0 °F
		K	05	K2	0.0 to 400.0 °C	0.0 to 750.0 °F
		K	06	K3	0.0 to 800.0 °C	0.0 to 1500.0 °F
		K	07	K4	0.0 to 1370.0 °C	0.0 to 2500.0 °F
		K *2	08	K5	-200.0 to 200.0 °C	-300.0 to 400.0 °F
		E	09	E	0.0 to 700.0 °C	0.0 to 1300.0 °F
		J	10	J	0.0 to 600.0 °C	0.0 to 1100.0 °F
		T *2	11	T	-200.0 to 200.0 °C	-300.0 to 400.0 °F
		N	12	N	0.0 to 1300.0 °C	0.0 to 2300.0 °F
		PL II	13	PLII	0.0 to 1300.0 °C	0.0 to 2300.0 °F
		PR40 - 20 *3	14	PR40-20	0.0 to 1800.0 °C	0 to 3300 °F
		WRe5-26	15	WRe5-26	0.0 to 2300.0 °C	0 to 4200 °F
		U	16	U	-200.0 to 200.0 °C	-300.0 to 400.0 °F
		L	17	L	0.0 to 600.0 °C	0.0 to 1100.0 °F
		K *4	18	K	10.0 to 350.0 K	10.0 to 350.0 K
		AuFe-Cr *5	19	AuFe - Cr	0.0 to 350.0 K	0.0 to 350.0 K
	RTD	Pt100 (old) JIS/IEC		31	Pt 1	-200.0 to 600.0 °C
			32	Pt 2	-100.00 to 100.00 °C	-150.0 to 200.0 °F
			33	Pt 3	-100.0 to 300.0 °C	-150.0 to 600.0 °F
			34	Pt 4	-60.00 to 40.00 °C	-80.00 to 100.00 °F
			35	Pt 5	-50.00 to 50.00 °C	-60.00 to 120.00 °F
			36	Pt 6	-40.00 to 60.00 °C	-40.00 to 140.00 °F
			37	Pt 7	-20.00 to 80.00 °C	0.00 to 180.00 °F
			38	Pt 8 *6	0.000 to 30.000 °C	0.00 to 80.00 °F
			39	Pt 9	0.00 to 50.00 °C	0.00 to 120.00 °F
			40	Pt10	0.00 to 100.00 °C	0.00 to 200.00 °F
			41	Pt11	0.00 to 200.00 °C	0.0 to 400.0 °F
			42	Pt12 *7	0.00 to 300.00 °C	0.0 to 600.0 °F
			43	Pt13	0.0 to 300.0 °C	0.0 to 600.0 °F
			44	Pt14	0.0 to 500.0 °C	0.0 to 1000.0 °F



Input Type	Sensor Type	Code	Symbol	Measuring range	Measuring range
Universal Input	RTD JPt100 (old)JIS	45	JPt 1	-200.0 to 500.0 °C	-300.0 to 900.0 °F
		46	JPt 2	-100.00 to 100.00 °C	-150.0 to 200.0 °F
		47	JPt 3	-100.0 to 300.0 °C	-150.0 to 600.0 °F
		48	JPt 4	-60.00 to 40.00 °C	-80.00 to 100.00 °F
		49	JPt 5	-50.00 to 50.00 °C	-60.00 to 120.00 °F
		50	JPt 6	-40.00 to 60.00 °C	-40.00 to 140.00 °F
		51	JPt 7	-20.00 to 80.00 °C	0.00 to 180.00 °F
		52	JPt 8 *6	0.000 to 30.000 °C	0.00 to 80.00 °F
		53	JPt 9	0.00 to 50.00 °C	0.00 to 120.00 °F
		54	JPt10	0.00 to 100.00 °C	0.00 to 200.00 °F
		55	JPt11	0.00 to 200.00 °C	0.0 to 400.0 °F
		56	JPt12 *7	0.00 to 300.00 °C	0.0 to 600.0 °F
		57	JPt13	0.0 to 300.0 °C	0.0 to 600.0 °F
		58	JPt14	0.0 to 500.0 °C	0.0 to 900.0 °F
Voltage (mV)	-10 to 10 mV	71	-10 to 10 mV	Initial value: 0.0 to 100.0 Measuring range: Any value in the following ranges can be set by the scaling function. Scaling range: -19999 to 30000 digit Span: 10 to 30000 digit Scale over occurs when the input measured value exceeds 32000.	
	0 to 10 mV	72	0 to 10 mV		
	0 to 20 mV	73	0 to 20 mV		
	0 to 50 mV	74	0 to 50 mV		
	10 to 50 mV	75	10 to 50 mV		
	0 to 100 mV	76	0 to 100 mV		
	-100 to 100 mV	77	-100 to 100 mV		
Voltage (V)	-1 to 1 V	81	-1 to 1 V	When used with 0 to 20 mA, 4 to 20 mA current input, select either of measuring range codes 84 and 85, and attach a shunt resistor of 1/2W 250Ω±0.1% to the input terminals.	
	0 to 1 V	82	0 to 1 V		
	0 to 2 V	83	0 to 2 V		
	0 to 5 V	84	0 to 5 V		
	1 to 5 V	85	1 to 5 V		
	0 to 10 V	86	0 to 10 V		
	-10 to 10 V	87	-10 to 10 V		
<p>*1: In the case of thermocouple B, accuracy is not guaranteed at temperatures 400°C and 750°F or below.</p> <p>*2: Accuracy at temperatures -100°C (-148°F) or below ±(0.5%FS+1 digit).</p> <p>*3: Accuracy is ±(0.3%FS+1°C).</p> <p>*4: Accuracy of thermocouple K is ±(0.75%FS+1K)/10.0 to 30.0K, ±(0.30%FS+1K)/30.0 to 70.0K, ±(0.25%FS+1K)/70.0 to 350.0K.</p> <p>*5: Accuracy of the AuFe-Cr thermocouple is ±(0.25%FS+1K).</p> <p>*6: Higher limit scale over occurs when the input measured value exceeds 32.000.</p> <p>*7: Higher limit scale over occurs when the input measured value exceeds 320.000.</p>					

## 7-4 Unit

Select the unit to be used in the preset measuring range.

Before performing setup or changes to the setup, set control action to the standby mode (STBY: ON).

For details on control standby operation, see "15-8 Control Standby (STBY)."

Only temperature (°C, °F) can be selected for RTD and TC input.

7-2

RANGE:	86 (0~ 10V)
Sc_L:	0.0°C
Sc_H:	100.0°C
UNIT:	°C DP: XXXX.X

RTD, TC

Setting range °C, °F

Initial value °C

Voltage, Current

Setting range °C, °F, %, None

Initial value %

When the unit is changed in the above screen, the following confirmation message will be displayed at TC and RTD input. At voltage or current input, this warning message will not be displayed.

Press the  key to select YES, and press the  key to apply the setting. The unit will be changed.

<b>WARNING</b>	→	<b>WARNING</b>
Params Initialize		Params Initialize
proceed? <b>NO</b>		proceed? <b>YES</b>

### Caution

- ◆ When the unit is changed, the above warning message will be displayed, and parameters will be initialized. For details on parameters that are initialized, see "17 List of Parameters."

## 7-5 Decimal Point Position

### (1) Decimal point position

Set the decimal point position in the PV display screen when the selection range is voltage input and current input (corresponding to code Nos.71 to 77, 81 to 87).

Before performing setup or changes to the setup, set control action to the standby mode (STBY: ON).

For details on control standby operation, see "15-8 Control Standby (STBY)."

The key mark is displayed and this item cannot be set in the case of RTD or TC input.

7-2

RANGE :	86 (0~ 10V)
Sc_L :	0.0%
Sc_H :	100.0%
UNIT :%	DP: XXXX.X

Setting range xxxx.x to x.xxxx

Initial value xxxx.x

**(2) Switching the lowest digit past the decimal point**

The lowest digit past the decimal point of measuring ranges determined by the range setting can be set.

Note, however, that this function cannot be used for measurement ranges without digits past the decimal point.

This screen is not displayed in the case of voltage input and current input.

7-3

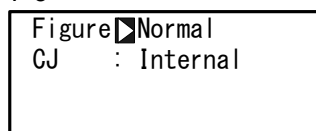

Setting range

Normal, Short

Initial value

Normal

Normal Displays the measuring range indicated in the Measuring Range Code Table.

Short Discards the lowermost digit past the decimal point of the measuring range indicated in the Measuring Range Code Table.

The EVENT/DO and PV Bias setting ranges do not change even if Figure is set to Short. When EVENT/DO and PV Bias is set with Figure set to Short and Normal is switched to, the values of EVENT/DO and PV Bias sometimes change.

When "Figure" is changed in the above screen, the following confirmation message will be displayed.

Press the  key to select YES, and press the  key to apply the setting. "Figure" will be changed.

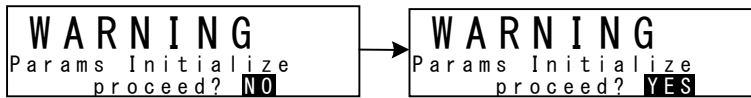

## Caution

- ◆ When the unit is changed, the above warning message will be displayed, and parameters will be initialized. For details on parameters that are initialized, see "17 List of Parameters."

## 7-6 Cold Junction Compensation

### (1) Thermocouple cold junction compensation

Set whether to perform cold junction compensation during TC input (corresponding to code Nos. 01 to 19) internally or externally.

Normally, set to internal compensation. Set to external compensation when greater accuracy is required.

7-3

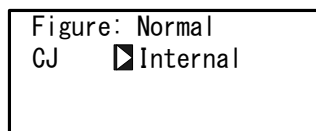

Setting range

Internal, External

Initial value

Internal

## 8 I/O AUXILIARY SETTINGS

### 8-1 PV Compensation Value

#### (1) PV bias

This item is used to compensate for error in the indicated temperature, for example, in the sensor/connected peripherals.

7-1

PV Bias	<input type="text" value="0.0"/>
PV Filter	<input type="text" value="OFF"/>
PV Slope	<input type="text" value="1.000"/>

Setting range -10000 to 10000 digit

Initial value 0 digit

#### (2) PV filter

When the PV signal contains noise, the control result sometimes is adversely affected by fluctuation of PV signals.

The PV filter is used to decrease this influence and stabilize control.

7-1

PV Bias	<input type="text" value="0.0"/>
PV Filter	<input checked="" type="checkbox"/> OFF
PV Slope	<input type="text" value="1.000"/>

Setting range OFF, 1 to 100s

Initial value OFF

PV filtering is performed by First Order Lag computation.

The filter time constant can be set up to 100 seconds.

When a large time constant is set, noise removal performance increases. However, in control systems having a fast response, noise removal is adversely affected.

#### (3) PV slope

This item sets the PV slope during voltage input and current input.

The screen is not displayed during RTD and TC input.

7-1

PV Bias	<input type="text" value="0.0"/>
PV Filter	<input type="text" value="OFF"/>
PV Slope	<input checked="" type="checkbox"/> 1.000

Setting range 0.500 to 1.500

Initial value 1.000

Execution  $PV = A \times X + B$  where,  $A = PV$  slope,  $B = Bias$ ,  $X = PV$  input

When this item is used in combination with square root extraction operation and linearizer approximation, this slope is applied to the result of square root extraction operation and linearizer approximation.

## 8-2 Square Root Extraction Operation

Signals having square root characteristics such as in the measurement of flow rates can be linearized.

This item is set during voltage input and current input.

This item is not displayed in the case of RTD or TC input.

### (1) Enabling the square root extraction operation

The square root extraction operation function is valid when SQ.Root is set to ON.

7-3

SQ. Root <input checked="" type="checkbox"/> OFF
--

Setting range OFF, ON

Initial value OFF

### (2) Low cut

This item functions only when the square root extraction operation function is enabled.

In square root operation, the PV fluctuates greatly by a slight fluctuation of the input value in the vicinity of signal zero.

"Low cut" is a function for outputting "0" (zero) to PV at the preset input value or lower.

Setting low cut prevents action from becoming unstable when there is noise on the input signal line.

7-3

SQ. Root <input checked="" type="checkbox"/> ON
Low Cut: 1.0%

Setting range 0.0 to 5.0%

Initial value 1.0%

The set value of low cut is 0.0 to 5.0% of the PV input range.

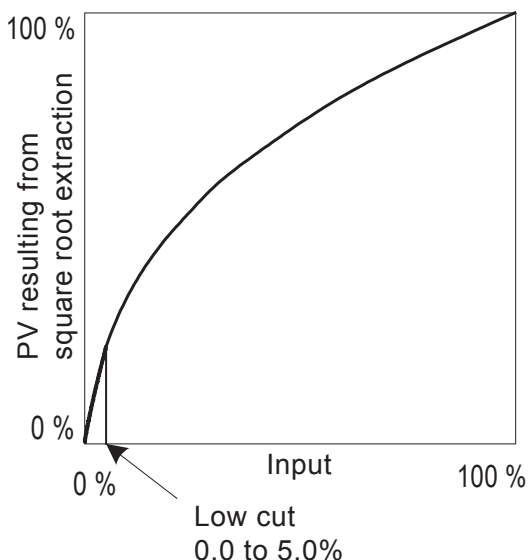

## 8-3 Control Output

### (1) Action characteristics

Select either reverse action (heating specifications) or direct action (cooling specifications) as the output characteristics.

6-1

OUT1 ACT	<input checked="" type="checkbox"/>	Reverse
STBY:		0.0%
ERR:		0.0%
CYC:		30s

Setting range      Reverse, Direct  
Initial value      Reverse

**Reverse**      By this action, the smaller the measured value (PV) than the set value (SV), the higher the output.

This action is generally used for heating control.

**Direct**      By this action, the larger the measured value (PV) than the set value (SV), the higher the output.

This action is generally used for cooling control.

*Note*

---

- ◆ Output characteristics cannot be switched during execution of auto tuning (AT).
- 

### (2) Output at standby

This function maintains control value at a fixed value during a standby (STBY: ON, controller operation paused). (preset value)

6-1

OUT1 ACT:		Reverse
STBY	<input checked="" type="checkbox"/>	0.0%
ERR:		0.0%
CYC:		30s

Setting range      0.0 to 100.0%  
Initial value      0.0%

*Note*

---

- ◆ In ON-OFF control (P=OFF), when output at standby is set to 50% or more, the actual output at standby becomes 100%. When output at standby is set to 49.9% or less, the actual output at standby becomes 0%.
  - ◆ Output at standby is maintained without being affected even if an error occurs.
-

### (3) Output at error

Control operation stops when an error occurs. This item, however, is used to maintain output at a fixed value without setting the control output value at that time to 0% (or OFF). Set output when an error occurs.

6-1

OUT1 ACT:	Reverse
STBY:	0.0%
ERR:	0.0%
CYC:	30s

Setting range 0.0 to 100.0%  
Initial value 0.0%

#### Note

- ◆ In ON-OFF control (P=OFF), when output at error is set to 50% or more, the actual output at error becomes 100%.  
When output at error is set to 49.9% or less, the actual output at error becomes 0%
- ◆ Output at standby is given priority when an error has occurred at Standby.

### (4) Proportional cycle time

This setting item is available only for contact output (Y) and SSR drive output (P). Set the output ON-OFF cycle time in second units.

In control systems having a fast response, favorable control results can be obtained if a short proportional cycle time (cycle time) is set.

6-1

OUT1 ACT:	Reverse
STBY:	0.0%
ERR:	0.0%
CYC:	30s

Setting range 1 to 120s  
Initial value Contact output (Y): 30s  
SSR drive output (P): 3s

#### Note

- ◆ If a short time is set as the proportional cycle time in contact output, the contact life of the output relay may be adversely affected. Pay particular attention to this point when setting the proportional cycle time.
- ◆ If a long time is set as the proportional cycle time in a control system with a short delay time, the control result will be adversely affected.
- ◆ The proportional cycle time cannot be set during execution of auto tuning (AT) or ramp control action.

### (5) Setting output 2

This setting item is available only when the 2-output specification is selected, and is not displayed for a 1-output specification.

The setup method and cautions for parameters are the same as those for Output 1.

	Setting range	Initial value
OUT2 ACT: <input checked="" type="checkbox"/> Direct	ACT : Reverse, Direct	Direct
STBY: 0.0%	STBY : 0.0 to 100.0%	0.0%
ERR: 0.0%	ERR : 0.0 to 100.0%	0.0%
CYC: 30s	CYC : 1 to 120s	Contact output (Y) 30s SSR drive output (P) 3s



**(6) Rate-of-change limiter**

This setting item limits the rate-of-change (%) per second.

This setting item can be set for each of output 1 (OUT1) and output 2 (OUT2: 2-output specification only).

Setting this item to OFF disables the rate-of-change limiter.

Set this setting item when a control target that is adverse sudden changes in output is used.

6-2

Rate Limiter
OUT <input checked="" type="checkbox"/> OFF
OUT2: OFF

Setting range OFF, 0.1 to 100.0%/s

Initial value OFF

**8-4 Ten-Segment Linearizer Approximation****(1) Enabling ten-segment linearizer approximation**

This setting is only for voltage input and current input.

This function performs linearization based upon ten-segment approximation when the PV input is a non-linear signal.

7-4

PMD <input checked="" type="checkbox"/> OFF
---

Setting range OFF, ON

Initial value OFF

**(2) Setting input points**

Set the input points in the case of ten-segment linearizer approximation input.

Up to 11 points can be set. 11 points (B1 to B11) can be set for PV display (%) on PV 11 inputs (A1 to A11).

For each input point, B1 is set to A1, B2 for A2 and so forth until B11 is set to A11, and linear interpolation is executed between input points.

7-4~7-9

PMD: ON
A 1 <input checked="" type="checkbox"/> 0.00%
B 1: 0.00%

Set the PV display value (B) to PV input value (A).

Setting range An, Bn: -5.00 to 105.00%

Initial value An, Bn: 0.00%

n=1 to 11

A10 <input checked="" type="checkbox"/> 90.00%
B10: 90.00%
A11: 100.00%
B11: 100.00%



### ■ Ten-segment linearizer setting (example)

In the following figure, A1, B1 to A6, B6 are used to set input points with four intermediate points.

For before A1 and from A6 onwards, the ramps of (A1, B1) to (A2, B2) and the ramps of (A5, B5) to (A6, B6) are applied.

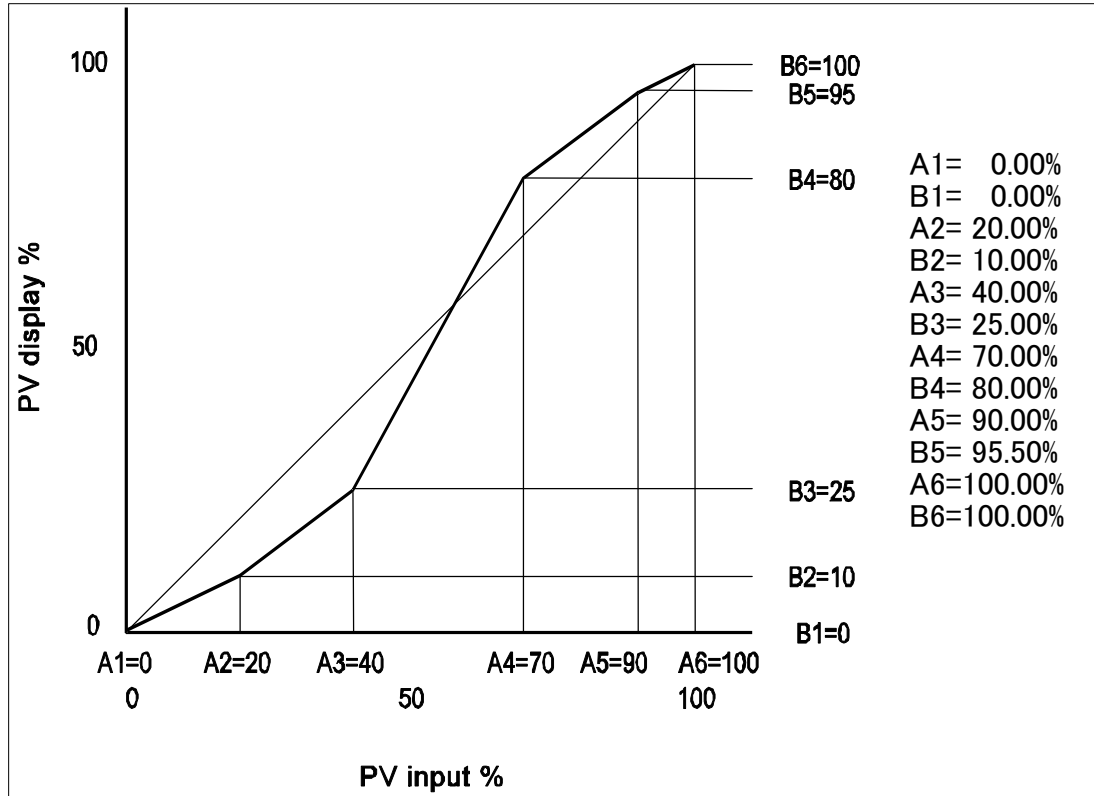

## Caution

- ◆ Set so that the relationship  $A_n < A_{(n+1)}$  is satisfied. When the relationship becomes  $A_n \geq A_{(n+1)}$ ,  $A_{(n+1)}$  onwards becomes invalid.

### 8-5 Compensating Control Output/Analog Output

Error that occurs in control output or analog output can be compensated.

1. Release the key lock if it is applied.  
For details on how to release the key lock, see "6-2 Releasing the Key Lock."
2. Set controller control action to the standby mode (STBY: ON).  
For details on control standby operation, see "15-8 Control Standby (STBY)."
3. Set the count value.  
Call up the LOCK, etc. top screen (group 8) from the basic screen by the **GRP** key.

Move to the setup screen by holding the **ENT** key and pressing the **GRP** key for at least 3 seconds, and select the output to compensate by pressing the **SCRN** and **↺** keys. Set the count value currently displayed on the SV display with the **▼** or **▲** key, and press the **ENT** key to fix and register settings

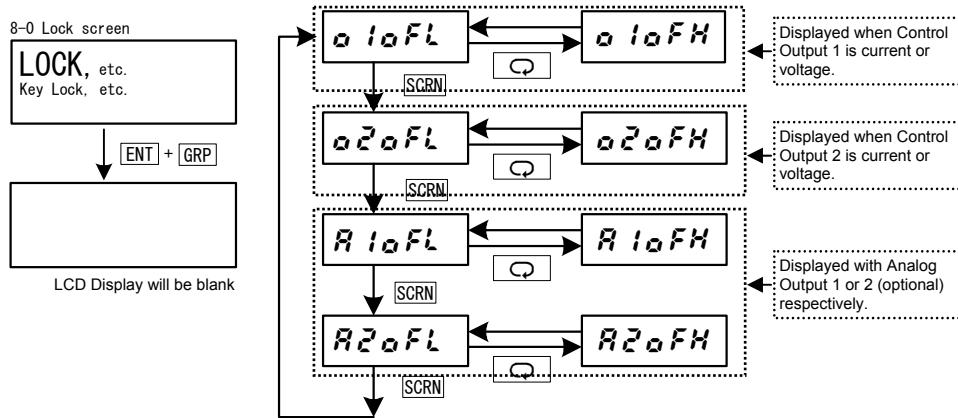

PV Display	Description	PV Display	Description
01oFL	Control Output 1 lower limit value	01oFH	Control Output 1 higher limit value
02oFL	Control Output 2 lower limit value	02oFH	Control Output 2 higher limit value
A1oFL	Analog Output 1 lower limit value	A1oFH	Analog Output 1 higher limit value
A2oFL	Analog Output 2 lower limit value	A2oFH	Analog Output 2 higher limit value

When "0" is set, settings return to factory defaults.

4. When you have finished setting the above, press the **DISP** key to return to the LOCK, etc. screen.

This page left intentionally blank.

## 9 SV VALUE & REMOTE SV VALUE

### 9-1 Setting the SV Value

#### (1) SV limiter

The SV limiter is used to prevent input of wrong target set values.  
Set the lower limit value (SV L) and higher limit value (SV H) of the set value (SV) setting range.

2-12

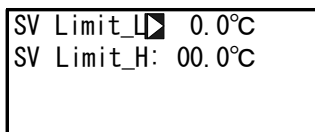

```
SV Limit_L 0.0°C
SV Limit_H: 00.0°C
```

Setting range Within measuring range  
SV Limit\_L < SV Limit\_H

Initial value

SV Limit\_L: Lower limit value of measuring range

SV Limit\_H: Higher limit value of measuring range

The SV limiter set here is valid on all execution SVs.  
The remote execution SV monitor is not influenced by the SV limiter, and indicates the value corresponding to the remote input value.  
The execution SV is restricted by the SV limit value.

### Caution

- When the SV limiter is changed after the SV value is set, SV values that fall outside the limit are discarded, and sometimes the setting is disabled. To avoid this state, be sure to set the SV limiter before setting the SV value.

#### (2) Set value (SV)

For details on how to set and change the currently executing SV, see "15-3 Setting the Execution SV No." Operations in the SV setup screen are as follows:

- Enter the set value by the ◀, ▼ or ▲ key.
- Press the **ENT** key to fix and register the set value.

2-1



```
SV1 0.0°C
```

This screen is for setting the SV value of each SV No.

Setting range Within SV setting range

Initial value 0 or value of lower limit side of the measuring range, whichever is larger

## 9-2 Setting the Remote SV Value

### (1) Monitoring the remote SV

The remote input signals are displayed in the REM set value monitor screen corresponding to the measuring range.

The remote SV value cannot be set by operating the front panel keys.

2-11

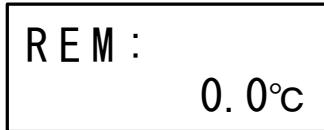

The remote SV monitor displays the values corresponding to the remote input values without being influenced by the SV limit.

### (2) Remote tracking

This function copies the remote SV value to the local SV value of any SV No.

The control program can be run while the SV value is changed by the analog remote signal, and fixed-value operation can be switched to by the remote SV value at a certain moment in time.

2-13

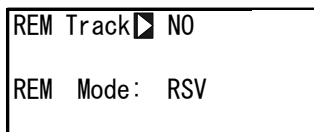

Selection item	NO, YES
Initial value	NO

#### ■ Operation at REM Track: YES

When the execution SV is switched to by key operation from the remote SV, the remote SV value is written to the SV value of the newly switched to SV No.

When REM is assigned to DI, and the remote SV is switched to the execution SV by an external contact signal, the remote SV value is copied to the switch destination SV value.

When EXT is set by SV No. selection switching, and the execution SV selected by an external switch is switched to from the remote SV, the remote SV value is copied to the switch destination SV value.

Remote tracking does not function when the remote SV value results in a scale over error.

#### ■ Operation at REM Track: NO

Remote tracking does not function.

**(3) Remote mode**

Various computations can be performed on remote signals, and the result taken as the remote SV.

In the RSV mode, the "Ratio:" row in the following screen is not displayed.

2-13

REM Track: NO
REM Mode <input checked="" type="checkbox"/> RT
Ratio: 1.000

Setting item	RSV, RT
Initial value	RST (Ratio is not displayed.)

RSV

The remote input is used as the regular RSV (remote SV) input.

RT

Computations are performed on the remote input signal values and used with ramp applied.

A bias can also be added to input signal values.

For details on RT, see "9-3 (1) Remote Ratio."



### 9-3 Setting the Remote SV Compensation Value

#### (1) Remote ratio

This item is valid only when RT is selected in the Remote Mode.

Set the value of A in the following formula for generating the remote SV (REM SV):

$$\text{REM SV} = A \times X + B$$

A: Remote ratio, B: Remote bias X: Remote input signal

2-13

REM Track: NO
REM Mode: RT
Ratio <input type="checkbox"/> 1.000

Setting range 0.001 to 30.000

Initial value 1.000

When ratio is set to remote (bias = 0)

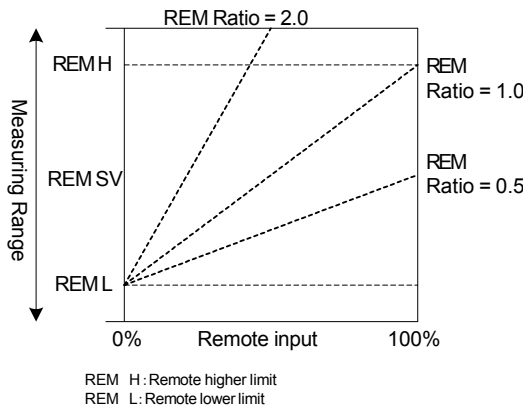

When ratio and bias are set to remote

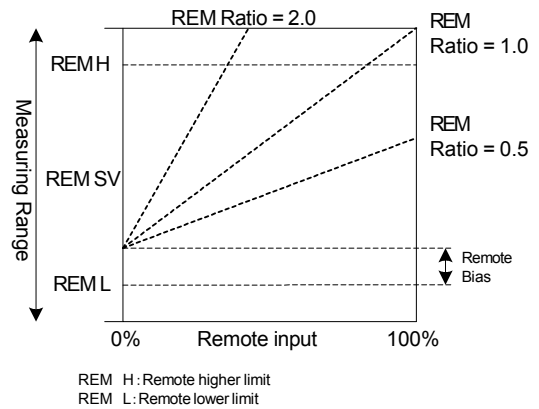

In the RT mode, generate the remote SV value by scaling the remote input signal, applying the remote ratio on the result of scaling, and applying a bias if required. For details on remote bias, see "9-3 (2) Remote bias," and for details on remote scaling, see "9-3 (4) Remote scale."

**Note**

- ◆ When an extremely large remote ratio is set, the range that can be used as the remote signal input becomes extremely narrow, and when an extremely small remote ratio is set, the range of the remote SV becomes extremely narrow. Applying a large bias further narrows the usable range. Take the above points into consideration when using this function.
- ◆ The REM SV value obtained by generating and computing remote SV is subject to restrictions by the SV limit value.

**(2) Remote bias**

Set the value of B in the following formula for generating the remote SV (REM SV):

In RT mode            REM SV = A x X + B  
 In RSV mode         REM SV = X + B

A: Remote ratio,    B: Remote bias,    X: Remote input signal

2-14

REM Bias	<input checked="" type="checkbox"/>	0.0 °C
Filt:		OFF
Sc_L:		0.0 °C
Sc_H:		800.0 °C

The error of the remote input signal can be compensated.

Setting range    -10000 to 10000 digit  
 Initial value    0 digit

Though the remote bias can be set up to  $\pm 10000$  digit, the assured accuracy is the range 0 to 100% of the remote signal input value.

Take care to prevent the value that is actually used from exceeding this accuracy range.

**(3) Remote filter**

Noise on the remote input signal line sometimes causes unstable control.

For this reason, this device incorporates a remote filter function for reducing the influence of noise to stabilize control.

Filtering is performed by first order lag computation.

Here, set that time constant.

2-14

REM Bias:		0.0 °C
Filt	<input checked="" type="checkbox"/>	OFF
Sc_L:		0.0 °C
Sc_H:		800.0 °C

Setting range    OFF, 1 to 300  
 Initial value    OFF  
 Unit : seconds

Setting a large time constant increases noise removal performance. This, however, sometimes adversely influences control systems that require a fast response speed.

**(4) Remote scale**

Set the range that is to be used as SV by the remote input signal.  
Set scaling within the measuring range.

2-14

REM Bias:	0.0°C
Filt:	OFF
Sc_L <input checked="" type="checkbox"/>	0.0°C
Sc_H:	800.0°C

Setting range

Within measuring range  
(reverse scaling possible)  
 $Sc\_L \leq REM\ L, REM\ H \leq Sc\_H$

Initial value

REM L:

Lower limit of measuring range

REM H

Higher limit of measuring range

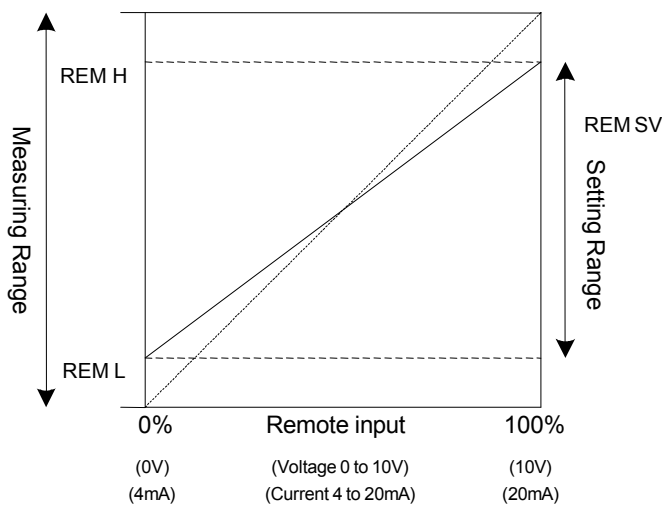

Set the value of remote input signal 0% to REM L.  
Set the value of remote input signal 100% to REM H.

In the case of reverse scaling, set the value of remote input signal 0% to REM H, and the value remote input signal 100% to REM L.

## 9-4 Setting the Remote PID No. and Square Root Extraction Operation

Set square root extraction operation when remote signals undergo square root extraction operation to produce the execution SV, for example, in ratio control of flow rates.

### (1) Setting the remote PID No.

The remote PID corresponding to the remote SV can be set.

Select the remote PID from PID No.1 to PID No.10.

Note, however, that the setting here becomes invalid when the zone PID function is in use.

2-15

REM PID	1
SQ. Root: OFF	

Setting range 1 to 10

Initial value 1

### (2) Enabling remote square root extraction operation function

The square root extraction operation is valid when SQ. Root is ON.

2-15

REM PID	1
SQ. Root <input type="checkbox"/> OFF	

Setting range OFF, ON

Initial value OFF

**(3) Low cut**

Low cut functions when square root extraction operation is valid.

In square root extraction operation, slight fluctuations of the input value near the signal zero cause the result to fluctuate considerably.

Low cut functions to set 0 (zero) to the REM signal when the input value is at the preset value or less.

This prevents action from becoming unstable when the REM input signal contains noise.

2-15

REM PID:	1
SQ. Root:	ON
Low Cut	<input checked="" type="checkbox"/> 1.0%

Setting range 0.0 to 5.0%

Initial value 1.0%

If REM signal is 1.0% or below,  
the value is adjusted to 0.

**9-5 Setting the Ramp**

This function gradually changes the set value without subjecting the load to sudden change when the target set value (SV) is changed.

Here, set four items: ascending ramp value (RAMP Up), descending ramp value (RAMP Down), ramp unit (RAMP Unit), and ramp ratio (RAMP Ratio).

**(1) Ramp value**

Set the ascending ramp value (RAMP Up) and descending ramp value (RAMP Down).

Ascending ramp or descending ramp is automatically selected at ramp execution.

When the ascending/descending ramp values are changed during execution of ramp control, they are immediately reflected in control.

2-16

RAMP	Up	<input checked="" type="checkbox"/>	OFF
	Down:		OFF
	Unit:		/Sec
	Ratio:		/1

Setting range RAMP Up : OFF, 1 to 10000

RAMP Down: OFF, 1 to 10000

Initial value RAMP Up : OFF

RAMP Down: OFF

**(2) Ramp unit time**

Set the unit times of ascending ramp value (RAMP Up) and descending ramp value (RAMP Down).

Set either seconds (Sec) or minutes (Min) as the unit time of the rate-of-change.

When the ramp unit time is changed during execution of ramp control, it is immediately reflected in control.

2-16

RAMP	Up:	OFF
	Down:	OFF
	Unit	<input checked="" type="checkbox"/> /Sec
	Ratio:	/1

Setting range /Sec, /Min

Initial value /Sec

### (3) Ramp ratio

Set this to use an even gentler slope in ramp control.  
 The amount of change per unit time can be set to 1/10 of the regular time.  
 When the ramp ratio is changed during execution of ramp control, it is immediately reflected in control.

2-16

RAMP	Up:	OFF
	Down:	OFF
	Unit:	/Sec
	Ratio	/1

Setting range /1, /10  
 Initial value /1

RAMP Ratio : /1 Ramp control is performed at the preset ramp unit time.  
 RAMP Ratio : /10 Ramp control is performed at 1/10 of the rate-of-change per unit.

### (4) Executing ramp control

Ramp control is executed by switching the execution SV No.  
 For details on switching this SV No., see "15-2 Switching the Execution SV No."  
 During execution of ramp control, the RMP status lamp blinks.  
 To abort ramp control and immediately execute steady-state control for switching to the target SV value, press the **ENT** and **DISP** keys simultaneously in the basic screen (group 0).  
 For details on operation of pausing/resuming ramp control, see "15-9 Pausing/Resuming Ramp Control (RAMP)."  
 While ramp control is paused, the RMP status lamp lights.

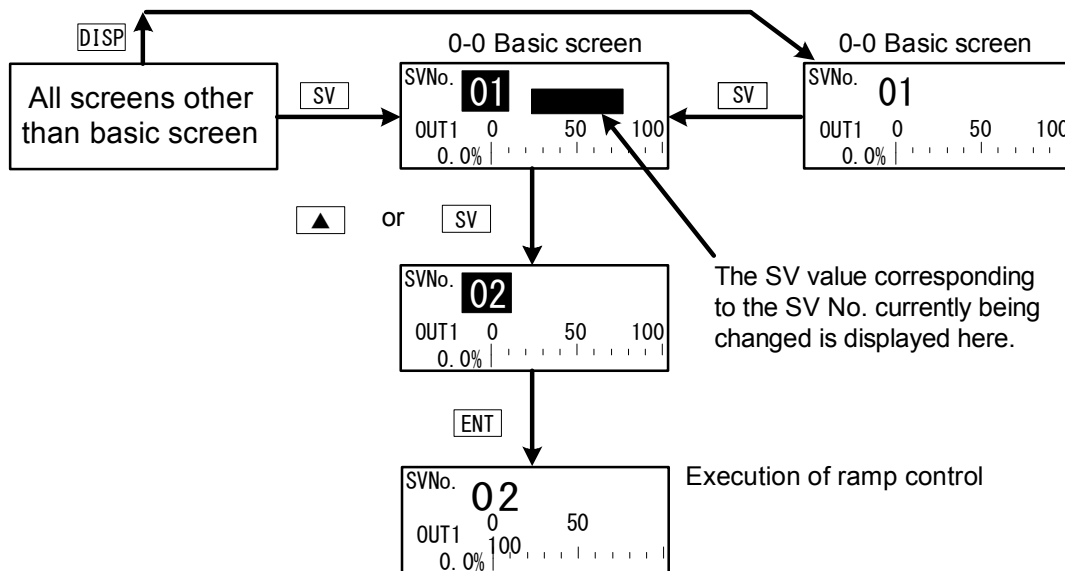

For execution of ramp control, the following conditions must be satisfied.

These conditions are common to both front panel keys and external switch input.

- ◆ Execution of auto tuning must not be in progress (AT: ON).
- ◆ The mode must not be standby (STBY: ON).
- ◆ RAMP Up or RAMP Down must not be OFF.

*Note*

- 
- ◆ Ramp control is not performed when the SV No. is switched to the remote SV.  
The same applies when the remote SV is switched to the local SV.
  - ◆ When the power is turned OFF during ramp control, and then turned back ON again, ramp control is stopped, and the execution SV is switched to the SV No. that was used as the target SV No.
-

## 10 PID SETTING

### 10-1 Proportional Band (P)

"Proportional band" refers to the range in which the size of the control output changes in proportion to the difference (deviation) between the measured value (PV) and the set value (SV).

Here, set the percentage (%) that control output is made to change with respect to the measuring range.

When a wide proportional band is set, the change in the control output with respect to deviation decreases, and the offset (constant deviation) increases.

When a narrow proportional band is set, the change in the control output increases, and the offset decreases. If too narrow a proportional band is set, hunting (vibration) occurs, and action becomes similar to that of ON-OFF control.

When P=OFF is set, control becomes ON-OFF control, and auto tuning cannot be executed.

3-1

PID01-OUT1		
P	3.0%	MR: 0.0%
I	120s	SF: 0.40
D	30s	

Setting range OFF, 0.1 to 999.9%

Initial value 3.0%

### 10-2 Integral Time (I)

Integral action is a function for correcting the offset (constant deviation) that occurs due to proportional action.

When a long integral time is set, offset correction action is weak, and it takes a long time to correct the offset. The shorter an integral time is set, the stronger the correction action becomes. However, if too short an integral time is set, hunting (vibration) occurs, and action becomes similar to that of ON-OFF control.

3-1

PID01-OUT1		
P	3.0%	MR: 0.0%
I	120s	SF: 0.40
D	30s	

Setting range OFF, 1 to 6000 s

Initial value 120 s

When auto tuning is executed with I=OFF, the manual reset (MR) value is computed and automatically set.

For details on automatic setting of MR, see "10-4 Manual Reset (MR)."



### 10-3 Derivative time (D)

Derivative action functions in two ways. It forecasts changes in the control output to reduce influence caused by external disturbance, and suppresses overshoot caused by integral action to improve control stability.

The shorter a derivative time is set, the weaker derivative action becomes. Alternatively, the longer a derivative time is set, the stronger derivative action becomes. However, if too long a derivative time is set, hunting (vibration) occurs, and action becomes similar to that of ON-OFF control.

3-1

PID01-OUT1	
P: 3.0%	MR: 0.0%
I: 120s	SF: 0.40
D: <input checked="" type="checkbox"/> 30s	

Setting range OFF, 1 to 3600 s  
Initial value 30 s

When auto tuning is executed with D=OFF, computation is performed only by PI value (proportional, integral).

### 10-4 Manual Reset (MR)

This function sets I (integral time) to OFF, and manually corrects offset that occurs when control action is performed by P or P+D.

When a + side MR value is set, the control result shifts to the + side, and when a - MR value is set, the control action shifts to the - side. The amount of shift is proportional to the size of the numerical value that is set.

3-1

PID01-OUT1	
P: 3.0%	MR <input checked="" type="checkbox"/> 0.0%
I: OFF	SF: 0.40
D: 30s	

Setting range -50.0 to 50.0 %  
Initial value 0.0 % (in 1-output specification)  
50.0 % (in 2-output specification)

#### ■ Automatic setting of MR

When auto tuning is executed, the manual reset (MR) value is computed and automatically set.

During PID control, the MR is used as the target load ratio in PID initial computation.

For this reason, to reduce overshoot when the power is turned ON or STBY is switched to EXE, set a small MR value to lower this target load ratio.

When auto tuning is performed by PID control on this device, the load ratio is calculated so that offset is decreased even if there is no I action, and the value corresponding to the manual reset is automatically set.

This function enables control results superior to those enabled by regular PID control to be obtained.

## 10-5 Action Hysteresis (DF)

This item sets the hysteresis (DF) in ON-OFF control action when P is set to OFF. When a narrow hysteresis is set, chattering is more likely to occur on the output. When a wide hysteresis is set, chattering, etc. can be avoided and stable control action can be obtained, however, ON-OFF cycling increases.

3-1

PID01-OUT1
P: OFF
DF <input checked="" type="checkbox"/> 2.0

Setting range 1 to 9999 digit  
Initial value 20 digit

## 10-6 Dead Band (DB)

This setting is for only the 2-output specification. Set the action range of output 2 (OUT2) taking the characteristics of the control target and energy savings into consideration.

PID01-OUT2
P: 3.0% DB <input checked="" type="checkbox"/> 0.0
I: OFF SF: 0.40
D: 30s

Setting range -19999 to 20000 digit  
Initial value 0 digit

The patterns in the following figures show the relationship between output action and dead band.

RA: Reverse Action, DA: Direct Action

### ■ Control Output 1:RA, Control Output 2: DA. (RA+DA)

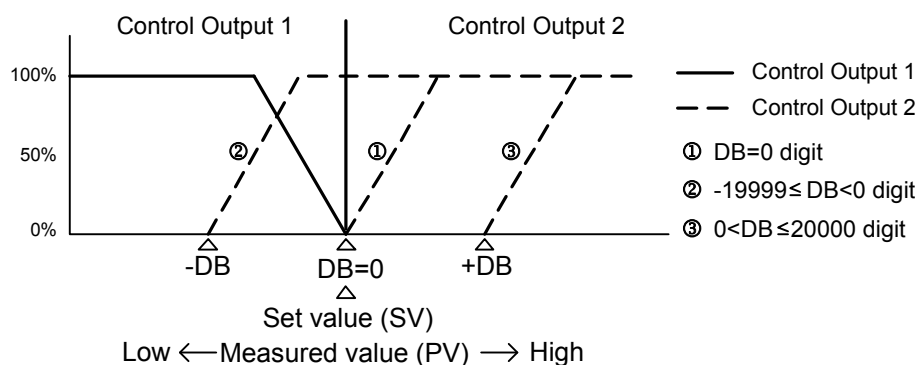

■ Control Output 1:RA, Control Output 2: RA. (RA+RA)

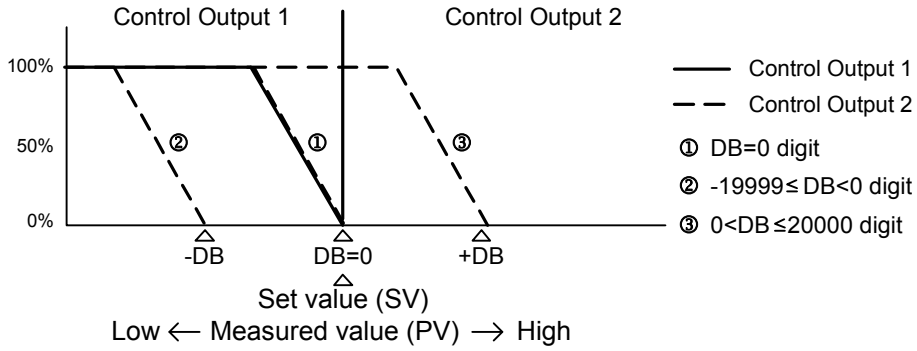

■ Control Output 1:DA, Control Output 2: RA. (DA+RA)

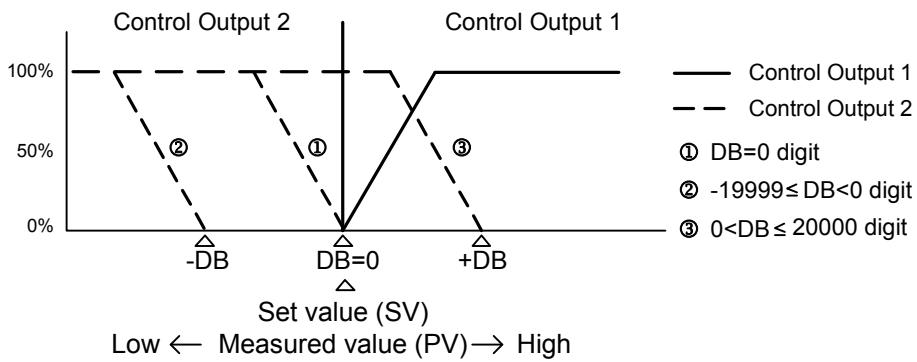

■ Control Output 1:DA, Control Output 2: DA. (DA+DA)

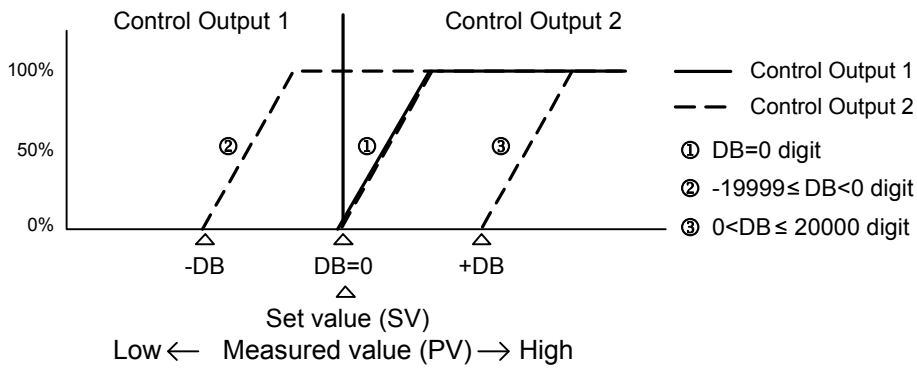

## 10-7 Set Value Function (SF)

This function determines the strength for preventing overshooting that occurs during Expert PID control.

Set Value Function is valid only when integral action (PI or PID) is set.

3-1

PID01-OUT1	
P: 3.0%	MR: 0.0%
I: OFF	SF <input checked="" type="checkbox"/> 0.40
D: 30s	

Setting range 0.00 to 1.00

Initial value 0.40

SF = 0.00 Regular PID control is carried out, and the overshoot correction function is disabled.

SF → Small Overshoot correction is small.

SF → Large Overshoot correction is large.

### ■Reference: About PID action according to set value function (SF)

PID and PD action can be switched by the SF value during RAMP or REM.

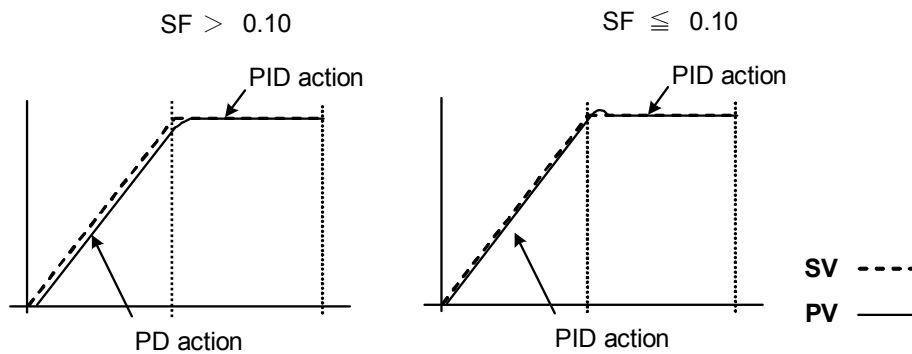

## 10-8 Output Limit Value (OUT1L to OUT2H)

This is the screen for setting the lower limit value and higher limit value of the control output value corresponding to the PID No.

Though regular control is performed using the initial values as they are, these lower limit and higher limit values are used for control that requires higher accuracy.

In a heating control specification, set a lower limit value when the return value is slow arriving due to overshoot at the upper side. For control targets whose temperature immediately drops when the temperature rise is slow and output is lowered, set a large higher limit value.

When the 2-output specification is selected, OUT1 is displayed on the upper row, and OUT2 is displayed on the lower row.

3-2

PID01	OUT1L ▾	0.0%
	OUT1H:	100.0%
	OUT2L:	0.0%
	OUT2H:	100.0%

Setting range Lower limit value : 0.0 to 99.9 %  
 Higher limit value : 0.1 to 100.0 %  
 (Lower limit value < Higher limit value)

Initial value Lower limit value : 0.0 %  
 Higher limit value : 100.0 %

*Note*

- ◆ The output limiter is invalid during contact output or SSR drive voltage output when P=OFF is set and ON-OFF control is selected.

## 10-9 Zone PID

This function sets two or more zones in a measuring range and switches different PID values in each zone for use.

When this function is used, the optimum PID value can be set to each temperature range (zone) so that satisfactory controllability is obtained in a wide temperature range as two or more SVs can be used for performing ramp control.

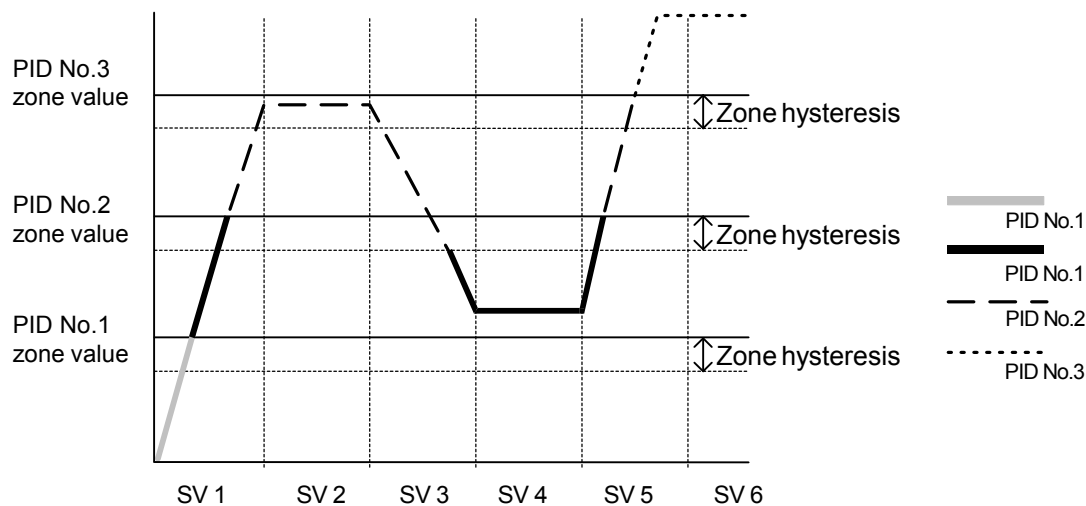

### Note

- ◆ When the same zone value is set to multiple PID Nos., the PID No. having the smallest No. is executed.
- ◆ Even if the zone value or zone hysteresis is changed with the SV value inside zone hysteresis, the execution PID No. will not be changed until the SV No. leaves zone hysteresis.

### (1) Selecting Zone PID

Select whether or not to use zone PID.

When this function is used, select whether to set the zone by SV or by PV.

3-21

Zone PID1	<input checked="" type="checkbox"/>	OFF
HYS1:		2.0

Setting range    OFF, SV, PV  
Initial value    OFF

OFF    Zone PID function is disabled.

PID No. is switched interlocked with the SV No.

SV    Zone PID function of SV is used.

PV    Zone PID function of PV is used.

**(2) Zone hysteresis**

The hysteresis can be set with respect to the zone set value.  
This hysteresis is valid for all zone set values.

3-21

Zone PID1:	OFF
HYS1	2.0

Setting range      0 to 10000 digit  
Initial value      20 digit

**(3) PID zone**

Set the zone (temperature range) to be used by the zone PID function for each PID No.

3-1

PID01-OUT1			
P:	3.0%	MR:	0.0%
I:	120s	SF:	0.40
D:	30s	ZN	0.0°C

Setting range      Within measuring range  
Initial value      0 digit

*Note*

- ◆ When the same zone value is set to two or more PID Nos., the PID having the smallest No. is executed.
- ◆ To use the Zone PID function, Zone hysteresis and Zone PID must be set.

## 10-10 Auto Tuning Point

To avoid hunting caused by limit cycle using the SV value in execution of PID auto tuning, set the AT action at the point where the PV leaves the SV value.

3-22

Tuning: Auto Tuning
Hunting: 0.2%
AT Point <input checked="" type="checkbox"/> 0.0°C

Setting range 0 to 10000 digit

Initial value 0 digit

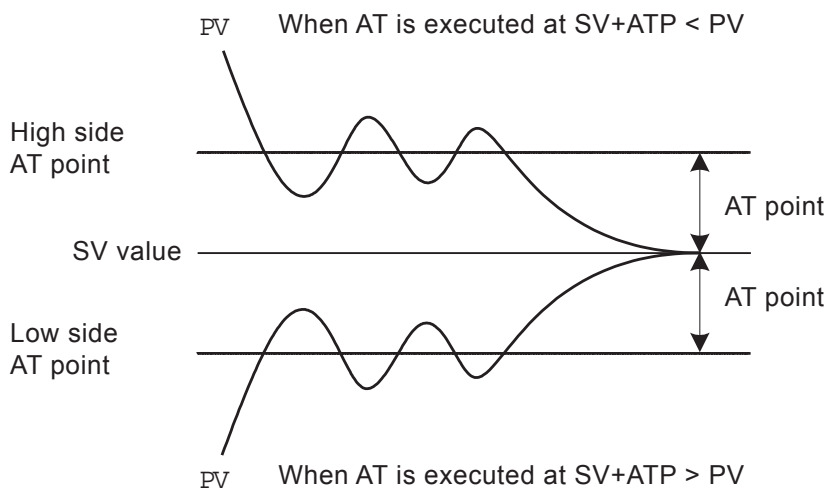

### Note

- ◆ For the AT Point setting, the AT action points above and below the SV value as a deviation are automatically set.
- ◆ If auto tuning is executed when PV is outside the preset upper and lower AT action points, auto tuning is performed at the AT action point between the PV and SV.
- ◆ If auto tuning is executed when the PV value is inside the upper and lower AT action points, auto tuning is performed by the SV value.
- ◆ When AT Point is set to 0 (zero), the SV value becomes the AT action point.



---

This page left intentionally blank.

# 11 EVENT & DO SETTING

## 11-1 Monitor Screens

### (1) DO monitor

4-1

D06	D07	D08	D09
□	□	□	□
D010	D011	D012	D013
□	□	□	□

When a signal is output to DO, □ is lit reversed to ■. DO6 to DO13 are optional, and are not displayed when they are not available.

### (2) Logic monitor

EV1	EV2	EV3
B     F & F	--	
D01	D02	D03
B     - F	--	

This screen is displayed when "LOGIC" is assigned to one or more EVENT/DOs.

LOGIC I: OR &: AND ^: XOR

Input B: Buffer F: Flip flop I: Inverter

Becomes white reversed on black in an active state.

In the screen above, Buffer and Inverter are assigned to DO1 to make the device perform OR operation on both inputs.

## 11-2 EVENT/DO Action

Note that if you have changed this setting, action set points (SP) and hysteresis (DF) parameters are initialized.

Some of the types of events that can be assigned vary according to the EV No. and DO No. DO6 to DO13 are optional.

Logic operations assignable to EV1 to EV3 and DO1 to DO3 are AND, OR and XOR.

Logic operations assignable to DO4 and DO5 are Timers and Counters.

4-2

EV1 SP: 2500.0°C
MD <input checked="" type="checkbox"/> DEV Hi ACT: N.O.
DF: 2.0°C IH: OFF
DLY: OFF STEV: OFF

Setting range See List of Event (EVENT/DO) Assignments.

Initial value EV1 : DEV Hi  
EV2 : DEV Low  
Others : None

### ■List of Event (EVENT/DO) Assignments

No.	Mode	Action	EV1 to EV3	DO1 to DO3	DO4 to DO5	DO6 to DO13
(1)	None	No action	○	○	○	○
(2)	DEV Hi	Higher limit deviation value	○	○	○	○
(3)	DEV Low	Lower limit deviation value	○	○	○	○
(4)	DEV Out	Outside higher/lower limit deviation	○	○	○	○
(5)	DEV In	Inside higher/lower limit deviation	○	○	○	○
(6)	PV Hi	PV higher limit absolute value	○	○	○	○
(7)	PV Low	PV lower limit absolute value	○	○	○	○
(8)	SV Hi	SV higher limit absolute value	○	○	○	○
(9)	SV Low	SV lower limit absolute value	○	○	○	○
(10)	AT	Auto tuning execution in progress	○	○	○	○
(11)	MAN	Manual operation in progress	○	○	○	○
(12)	REM	Remote operation in progress	○	○	○	○
(13)	RMP	Ramp control execution in progress	○	○	○	○
(14)	STBY	Control action not in progress	○	○	○	○
(15)	SO	PV, REM scale over	○	○	○	○
(16)	PV SO	PV scale over	○	○	○	○
(17)	REM SO	REM input scale over	○	○	○	○
(18)	LOGIC	Logic operation (AND, OR, XOR)	○	○	---	---
		Logic operation (Timer/Counter)	---	---	○	---
(19)	Direct	Direct output (option)	---	---	---	○
(20)	HBA	Heater break alarm output (option)	○	○	○	○
(21)	HLA	Heater loop alarm output (option)	○	○	○	○

 DLY can be set.

MD Indication	EVENT (DO) Type	Setting Range	Initial Value
DEV Hi	Higher limit deviation value	-25000 to 25000 digit	25000 digit
DEV Low	Lower limit deviation value	-25000 to 25000 digit	-25000 digit
DEV Out	Outside higher/lower limit deviation	0 to 25000 digit	25000 digit
DEV In	Inside higher/lower limit deviation	0 to 25000 digit	25000 digit
PV Hi	PV higher limit absolute value	Within measuring range	Measuring range higher limit value
PV Low	PV lower limit absolute value	Within measuring range	Measuring range lower limit value
SV Hi	SV higher limit absolute value	Within SV setting range	Higher limit value of SV
SV Low	SV lower limit absolute value	Within SV setting range	Lower limit value of SV

In the case of DEV Out and DEV In, two plus and minus action points are set when a deviation value is input.

Direct can be set with communication interface option.

## ■ EVENT/DO Action Diagrams

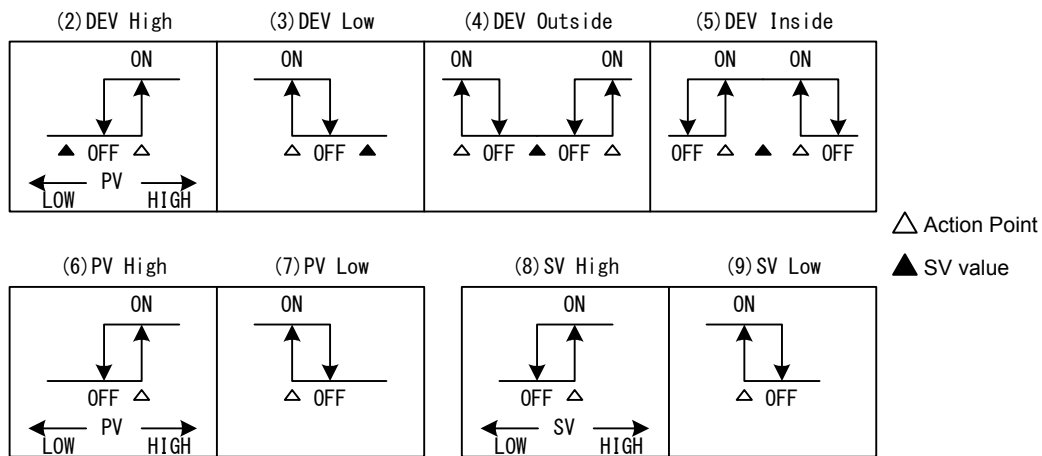

- ◆ ON/OFF in the diagrams indicate operation mode.  
EVENT/DO output conforms to the setting of output characteristics.

### (1) Output characteristics

Select the output characteristics.

4-2

EV1 SP: 2500.0°C	
MD: DEV Hi	ACT <input checked="" type="checkbox"/> N.O.
DF: 2.0°C	IH: OFF
DLY: OFF	STEV: OFF

Setting range    N.O., N.C.  
Initial value    N.O.

N.O.(normally open)    When EVENT/DO turns ON, contacts are closed or output transistor turns ON.

N.C.(normally closed)    When EVENT/DO turns ON, contacts are opened or output transistor turns OFF.

**(2) Hysteresis**

This item is displayed when event modes (2) to (9) are selected in EVENT/DO action. Set the hysteresis between ON action and OFF action. Setting a wide hysteresis can avoid chattering, etc. and obtain stable action.

4-2

Setting range 1 to 9999 digit  
Initial value 20 digit

EV1 SP: 2500.0°C
MD: DEV Hi ACT N. O.
DF <input checked="" type="checkbox"/> 2.0°C IH: OFF
DLY: OFF STEV: OFF

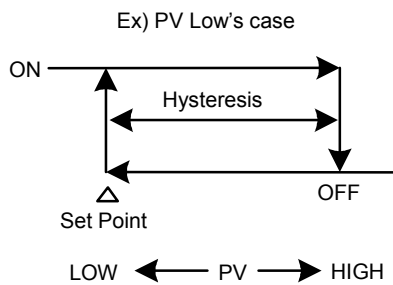
**(3) Delay time**

This item is displayed when event modes (2) to (9) are selected in the EVENT/DO action mode (MD).

This function delays the time until EVENT is output after generation of an event source.

4-2

Setting range OFF, 1 to 9999 s  
Initial value OFF

EV1 SP: 2500.0°C
MD: DEV Hi ACT N. O.
DF: 2.0°C IH: OFF
DLY <input checked="" type="checkbox"/> OFF STEV: OFF

**Note**

- ◆ EVENT/DO is not output when the source of the signal output disappears during the delay time. When the source is generated again, the event delay time up till then is cleared, counting of the item is performed from the beginning.
- ◆ When the delay time is set to OFF, EVENT/DO is output at the same time that the source of EVENT/DO is generated.
- ◆ The delay time can be changed when an EVENT/DO output source is generated and it is within the delay time action. Note, however, that the delay time is measured not from the moment that it is changed but from the moment that the output source is generated.
- ◆ The delay time for EVENT/DO action becomes invalid when a scale over occurs.

**(4) Inhibit action**

This item is displayed when modes (2) to (9) are selected in the EVENT/DO action.

Inhibit action does not output EVENT/DO even if the PV value is in the EVENT/DO action region, and outputs EVENT/DO when the PV value leaves the EVENT/DO action region and enters the EVENT/DO action region again at power ON or at STBY cancellation.

Select either of the following taking inhibit action and event action at a scale over into consideration.

4-2

EV1 SP: 2500.0°C
MD: DEV Hi ACT N. O.
DF: 2.0°C IH <input type="checkbox"/> OFF
DLY: OFF STEV: OFF

Setting range OFF, 1, 2, 3

Initial value OFF

OFF Inhibit action is not performed.

1 Inhibit action is executed at power ON or when the control state changes from standby to execution (STBY ON→OFF).

2 Inhibit action is executed at power ON, when the control state changes from standby to execution (STBY ON→OFF) or when the state of SV is changed.

3 Inhibit action is not performed. (Action OFF at scale over input error.)

**Note**

- ◆ When IH is set to 1 or 2, EVENT/DO action turns ON when a scale over error occurs on the EVENT/DO set side.
- ◆ When IH is set to 3, EVENT/DO action turns OFF when a scale over error occurs on the EVENT/DO set side.
- ◆ To output an alarm when a scale over error occurs with IH set to 3, assign scale over (SO) to other EVENT/DOS.

**(5) Event action at inhibit**

Select whether or not to perform event output during inhibit when event modes (2) to (9) are selected.

4-2

EV1 SP: 2500.0°C
MD: DEV Hi ACT N. O.
DF: 2.0°C IH: OFF
DLY: OFF STEV: <input checked="" type="checkbox"/> OFF

Setting range OFF, ON

Initial value OFF

OFF Event output becomes invalid during inhibit.

ON Event output becomes valid during inhibit.

### 11-3 Event Logic Operations

This function performs logic operations on inputs from two DIs and outputs the result to EVENT/DO.

This function sets a logic gate to each of the two inputs, performs logic operation (AND, OR or XOR) on these inputs, and outputs the result to EVENT/DO.

Events that can be selected are EV1 to EV3 and DO1 to DO3.

#### ■ Event logic operation block diagram and configuration example

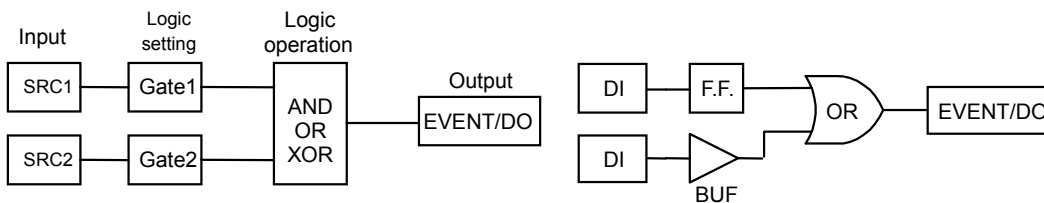

#### (1) Logic operation mode (Log MD)

The following screen is displayed when logic operation (LOGIC) is selected as the operation mode.

4-5

DO1	Log MD: AND
MD:	LOGIC ACT: N. O.
SRC1:	None Gate1: BUF
SRC2:	None Gate2: BUF

Setting range AND, OR, XOR  
Initial value AND

- AND Logical product EVENT/DO turn on when both of the two inputs turn on (logic 1).
- OR Logical sum EVENT/DO turn on when either the two inputs turns on (logic 1).
- XOR Exclusive OR EVENT/DO turn on when one of the two inputs turns on (logic 1) and the other turns off (logic 0).

#### (2) Assigning logic operation input (SRC1, SRC2)

Assign the DI No. to two inputs (SRC1 & SRC2) for logic operation. DI that can be assigned are DI1 to DI10 (DI5 to DI10 are optional).

4-5

DO1	Log MD: AND
MD:	LOGIC ACT: N. O.
SRC1:	None Gate1: BUF
SRC2:	None Gate2: BUF

Setting range DI1 to DI10  
Initial value None (no assignment)

**Note**

- ◆ When another function is assigned to DI and that DI signal is input, logic operation is executed and the function assigned to DI acts simultaneously.
- ◆ When logic operation input is set to None, the input logic becomes logic 0 regardless of the BUF, INV and FF settings.

### (3) Logic operation input logic (Gate1, Gate2)

Set the logic of the two inputs for logic operation.

4-5

D01	Log MD: AND
MD: LOGIC	ACT: N. O.
SRC1: None	Gate1: <input checked="" type="checkbox"/> BUF
SRC2: None	Gate2: BUF

Setting range    BUF, INV, FF  
Initial value    BUF

BUF    Buffer

DI input signals are handled as they are as input logic signals.

INV    Inverter

DI input signals are reversed and the result is handled as the input logic signal.

FF    Flip-flop

DI input signals are reversed and the result is handled as the input logic signal each time that the assigned DI turns ON.

When DI turns ON, that ON state is sustained even if it turns OFF later.

In this case, the input logic turns OFF when DI is ON next time.

#### Note

- The DI monitor indicator lights when an input signal is input. When Gate is set to INV, logic becomes Logic 1 when DI input is OFF, and Logic 0 when DI input is ON. For this reason, the logic state becomes the reverse of the DI monitor.
- When Gate is set to FF, the logic state is alternately switched between Logic 1 and Logic 0 each time that DI is input. For this reason, the logic state can be confirmed on the logic operation monitor.
- When DI assignment is set to None, no action is performed even if the DI signal is input.

## 11-4 Timers/Counters

With this timer/counter function, DI is taken as input and DO is taken as output.

When input is generated, and after it passes preset time/preset counts, DO is output.

The timers and counters operate regardless of the control action of this device, and output a one-shot pulse of one second.

Only DO4 and DO5 can be assigned for the timers and counters.

The following screen is displayed only when the operation mode is set to logic operation (LOGIC).

### (1) Timer time

The time can be set within the range 1 to 5000 seconds only when the mode (Log MD) is set to timer.

4-9

D05	Time <input checked="" type="checkbox"/> OFF
MD: LOGIC	ACT: N. O.
SRC: DI3	
Log MD: Timer	

Setting range    OFF, 1 to 5000 s  
Initial value    OFF



**(2) Counter**

The count can be set within the range 1 to 5000 only when the mode (Log MD) is set to counter.

The pulse width of DI must be 100 ms or more.

4-8

D04 Count	<input checked="" type="checkbox"/>	OFF
MD:	LOGIC	ACT: N.O.
SRC:	None	
Log MD:	Counter	

Setting range OFF, 1 to 5000

Initial value OFF

**(3) Assigning input (SRC)**

The DIs that can be assigned are DI1 to DI10 (DI5 to DI10 are optional).

4-9

D05 Time :	OFF	
MD:	LOGIC	ACT: N.O.
SRC	<input checked="" type="checkbox"/>	None
Log MD:	Timer	

Setting range None, DI1 to DI10

Initial value None (no assignment)

*Note*

- ◆ When another function is assigned to DI and that DI signal is input, logic operation is executed and the function assigned to DI acts simultaneously.
- ◆ When DI assignment is set to None, no action is performed even if the DI signal is input.

**(4) Mode (Log MD)**

Select and set timer or counter.

4-9

D05 Time :	OFF	
MD:	LOGIC	ACT: N.O.
SRC:	D13	
Log MD	<input checked="" type="checkbox"/>	Timer

Setting range Timer, Counter

Initial value Timer

Timer DO turns ON after DI is input and a preset time elapses.

Counter DO turns ON when DI input count reaches the preset value.

## 12 OPTION (DI, AO, HB, COM) SETTING

### 12-1 DI

DI is digital input for external control based upon an externally input non-voltage contact signal or an open collector signal.

Actions can be selected, and assigned to DI1 to DI10 (DI5 to DI10 are optional).

#### (1) DI monitor screen

is displayed reversed to  when a signal is input to DI regardless of whether or not DI is assigned.

DI5 to DI10 are optional and are not displayed when they are not available

5-1

DI1	DI2	DI3	DI4	DI5
<input type="checkbox"/>	<input type="checkbox"/>	<input type="checkbox"/>	<input type="checkbox"/>	<input type="checkbox"/>
DI6	DI7	DI8	DI9	DI10
<input type="checkbox"/>	<input type="checkbox"/>	<input type="checkbox"/>	<input type="checkbox"/>	<input type="checkbox"/>

#### (2) Selecting DI action

This is the assignment to DI.

LG is displayed for the DI to be used by input (SRC) in event logic operations. For details, See “11-3 (2) Assigning logic operation input (SRC1, SRC2)”.

5-2

DI1	<input checked="" type="checkbox"/>	None	
DI2	:	None	
DI3	:	None	LG
DI4	:	None	

## ■ List of DI Types

Mode	Action	No-action Conditions	Signal Detection
None	No action (factory default)	---	---
MAN	Switching of control output between auto/manual (when ON: manual)	AT, STBY	Level
REM	Switching of REM SV/LOCAL SV setting (when ON: REM SV setting)	AT	Level
AT	Switching of AT execution/stop (at ON "edge": AT execution)	MAN, STBY, RMP, REM	Edge
STBY	Switching of control execution/standby (when ON: standby)	None	Level
ACT	Switching of direct/reverse action on Output 1 characteristics (when ON: direct action)	AT, RMP	Level
ACT2	Switching of direct/reverse action on Output 2 characteristics (when ON: direct action)	AT, RMP	Level
Pause	Switching of pause/resume of ramp control (when ON: ramp pause)	---	Level
LOGIC	Logic operation (when ON: execution of logic operation and output to EV or DO)	None	Level
EXT_SV	External switching of SV No. Only DI7 can be set. (assigned to DI7 to DI10)	None	Level

### Note

- ◆ The corresponding DI action details cannot be executed while parameters listed in the "No-action Conditions" column in the DI Assignments Table are being executed.
- ◆ Signal detection timing:
 

Level input	Action is maintained with DI input ON.
Edge input	Action is executed by DI input ON, and is maintained even if DI input turns OFF. Action is canceled by DI input ON again.
- ◆ Once a function is assigned to a DI, the same function cannot be set by the front panel keys as DI is given priority.
- ◆ When the same action is assigned to two or more DIs, the DI having the smallest No. is valid, and DIs having a larger No. are invalid.  
For example, assignment to DI2 becomes invalid when MAN is assigned to DI1 and DI2.
- ◆ When a DI assignment is canceled during DI execution, the currently executing action is continued (excluding LOGIC operation).  
For details on logic operation, see "11-3 Event Logic Operations".

## 12-2 Analog Output

This function is optional and is not displayed when it is not installed.  
Two optional analog outputs (Ao1, Ao2) can be installed on this device.

### (1) Analog output type

Select the type of analog output to assign

5-5

Ao1MD	▣	PV
Ao1_L	▣	0.0°C
Ao1_H	▣	800.0°C

Setting range PV, SV, DEV, OUT1, OUT2

Initial value Ao1 : PV

Ao2 : SV

PV : Measured value

SV : Target set value

DEV : Deviation of PV and SV

OUT1 : Control Output 1

OUT2 : Control Output 2 (only with 2 output specification)

### (2) Scaling analog output

Set the lower limit/higher limit scale of analog output.  
Reverse scaling is also possible.

5-5

Ao1MD	:	PV
Ao1_L	▣	0.0°C
Ao1_H	▣	800.0°C

The following table shows setting ranges and initial values.

Analog Output Type	Setting Range	Initial Value	
		Ao1_L, Ao2_L	Ao1_H, Ao2_H
PV, SV	Within measuring range	Measuring range lower limit value	Measuring range higher limit value
DEV	-100.0 to 100.0%	-100.0 %	100.0%
OUT1, OUT2	0.0 to 100.0%	0.0 %	100.0%

### 12-3 Setting the Heater Break/Heater Loop Alarms

This function is optional and is not displayed when it is not available.

This function outputs an alarm when the heater has burned out during control (heater break) or when some trouble on the final control element causes a heater current to flow when output is OFF (heater loop error).

Alarm output is assigned to EVENT/DO (external output), and HBA (heater break alarm) or HLA (heater loop alarm) is assigned for use.

The heater break alarm and heater loop alarm can be used when Control Output 1 or Control Output 2 is a contact (Y) or SSR drive voltage (P).

These alarms cannot be used if control output is current (I) or voltage (V).

Hysteresis is fixed to 0.2A.

#### (1) Connecting the current transformer (CT)

Pass the load wire through the hole of the CT (provided with this device).

Wire from the CT terminal to the CT input terminal on this device.

The wire has no polarity.

For 30A CT CTL-6-S

For 50A CT CTL-12-S36-8

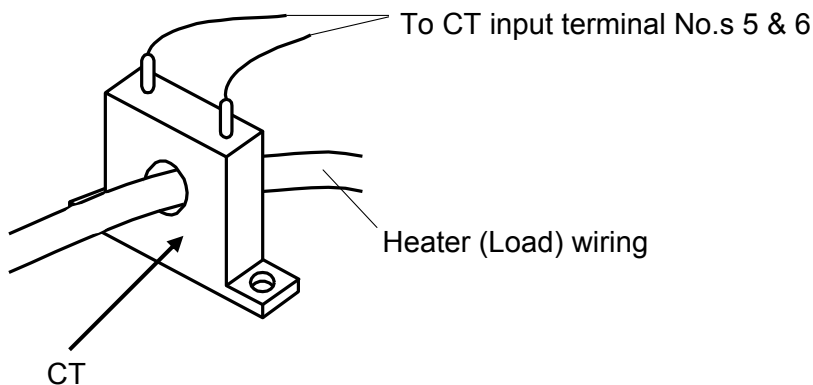

#### (2) Heater current monitor

The monitor displays the current value detected by the current transformer (CT).

5-7

```

Heater [ 0.0A]
HBA  OFF
HLA: OFF
HBM: Real    HB: OUT1
  
```

Display range: 0.0 to 55.5 A

When the detection current exceeds 55.0A, HB\_HH is displayed and when the current cannot be detected, "----" is displayed.

**(3) Heater Break Alarm current (HBA)**

An alarm is output when the current of the load wire is smaller than the preset value.

5-7

Heater [ 0.0A]
HBA <input checked="" type="checkbox"/> OFF
HLA: OFF
HBM: Real    HB: OUT1

Setting range    OFF, 0.1 to 50.0A

Initial value    OFF

---

*Note*

- ◆ To use Heater Break Alarm, HBA must be assigned for EVENT/DO in EVENT/DO group.
- 

**(4) Heater Loop Alarm current (HLA)**

An alarm is output when the current of the load wire is greater than the preset value.  
The alarm output is maintained even if control output turns ON during alarm output.

5-7

Heater [ 0.0A]
HBA: OFF
HLA <input checked="" type="checkbox"/> OFF
HBM: Real    HB: OUT1

Setting range    OFF, 0.1 to 50.0A

Initial value    OFF

---

*Note*

- ◆ To use Heater Loop Alarm, HLA must be assigned for EVENT/DO in EVENT/DO group.
- 

**(5) Heater Break/Heater Loop Alarm mode (HBM)**

Select the real mode or the lock mode as the alarm output mode.

5-7

Heater [ 0.0A]
HBA: OFF
HLA: OFF
HBM <input checked="" type="checkbox"/> Real    HB: OUT1

Setting range    Real, Lock

Initial value    Lock

**Real**    Once the alarm is output, alarm output is canceled when the heater current returns to normal.

**Lock**    Once the alarm can be output, alarm output is locked (fixed), and is output continuously even if the heater current returns to normal.

Alarm output is canceled by setting HBA and HLA to OFF or the power is turned OFF.

**(6) Heater Break detection selection (HB)**

Select the control output at which Heater Break is detected.

This parameter can be set when 2-output specification is selected, and specified either Y/Y, P/P, Y/P, P/Y for output1/output2.

5-7

Heater [ 0.0A]
HBA: OFF
HLA: OFF
HBM: Real HB <input checked="" type="checkbox"/> OUT1

Setting range OUT1, OUT2

Initial value OUT1

## 12-4 Communication

### (1) Setting communication

For details, refer to the separate manual "SR23 Series Digital Controller Communications (Interface) (RS-232C/RS-485) Instruction Manual (Detailed version)." This section explains only the setting items.

5-8

COM PROT	SHIMADEN
ADDR:	1
BPS :	9600
MEM :	EEP

PROT: Communication protocol  
 Setting range SHIMADEN, MOD\_ASC, MOD\_RTU  
 Initial value SHIMADEN

ADDR: Communication address  
 Setting range 1 to 98  
 Initial value 1

BPS: Communication speed  
 Setting range 2400, 4800, 9600, 19200  
 Initial value 9600

MEM: Communication memory mode  
 Setting range EEP, RAM, R\_E  
 Initial value EEP

5-9

COM DATA	7
PARI :	EVEN
STOP :	1
DELY :	10 ms

DATA: Data length  
 Setting range 7, 8  
 Initial value 7

PARI: Parity  
 Setting range EVEN, ODD, NONE  
 Initial value EVEN

STOP: Stop bit  
 Setting range 1, 2  
 Initial value 1

DELY: Delay time  
 Setting range 1 to 50ms  
 Initial value 10ms

5-10

COM CTRL	STX_ETX_CR
BCC:	ADD

CTRL: Control code  
 Setting range STX\_ETX\_CR, STX\_ETX\_CRLF, @:\_:CR  
 Initial value STX\_ETX\_CR

BCC: Block check character  
 Setting range ADD, ADD\_two's cmp, XOR, None  
 Initial value ADD



**(2) Communication mode (COM)**

Select whether or not to set or change various data using the front panel keys (local) or by communication (option).

1-2

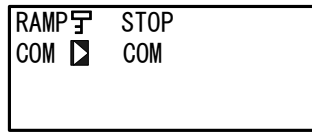
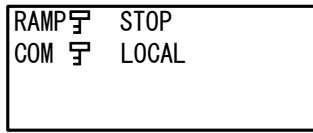

Setting range	LOCAL, COM
Initial value	LOCAL

In the Local mode, the key sign is displayed at the communication selection, indicating that changing from LOCAL (local) to COM (communication) by the front panel keys isn't possible.

Even in the LOCAL mode, the Communication mode can be changed from LOCAL to COM by sending commands to the SR23 from the host.

In the COM mode, the Communication mode can also be changed from COM to LOCAL by operating the front panel keys.

The COM (communication) and LOCAL (local) selections can be set by communications.

**LOCAL** Settings can be made using the front panel keys.  
(Settings cannot be made by communication.)

**COM** Settings can be made by communication.  
(Settings cannot be made by the front panel keys.)

For details on communication, refer to the separate manual "SR23 Series Digital Controller, Communications (Interface) (RS-232C/RS-485) Instruction Manual (Detailed version)."

# 13 KEY LOCK SETTING

## 13-1 Setting Key Lock

### (1) Displaying the key lock screen

To call up the LOCK, etc. screen group (group 8) from the basic screen, press the **GRP** key.

Press the **SCRN** key in the LOCK, etc. screen group to switch to the screens for making and changing setups.

Select parameters in screens by pressing the **↶** key.

Set parameters by pressing the **↵**, **⏴** or **⏵** key, and press the **ENT** key to fix and

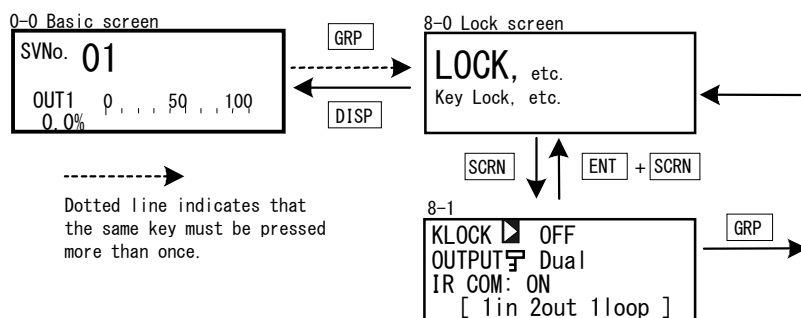

register settings.

### (2) Key lock

When the key lock is applied, **☒** (key mark) is displayed at the relevant parameter on the LCD screen, and the parameter cannot be set or changed.

8-1

```

KLOCK☒ OFF
OUTPUT: Single
IR COM: ON
[ 1in 1out 1loop ]
  
```

Setting range OFF, LOCK1, LOCK2, LOCK3  
Initial value OFF

- OFF Releases the key lock
- LOCK1 Locks parameters other than SV related, AT, MAN, and EVENT/DO parameters.
- LOCK2 Locks parameters other than SV related parameters
- LOCK3 Locks all parameters (excluding the key lock parameter itself)

For details on parameters that are locked, see "17 List of Parameters."

This page left intentionally blank.

# 14 MONITORING, EXECUTING & STOPPING OPERATION

Various monitor functions are grouped in the basic screen group (group 0). The configuration of this basic screen group, moving between screens and display details differ according to the specifications of the SR23 Series and selected options.

## 14-1 Flow of Basic Screen

### (1) 1-input specification

0-0 Basic screen

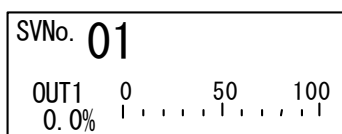

SV No., Output value display



1-output

0-1 Output Monitor

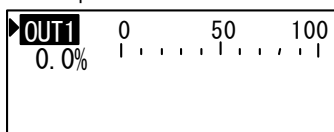

2-output

0-1

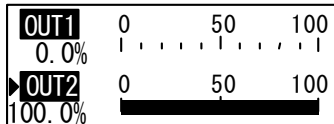

Output value displayed  
by % and bar graph

When the 2-output specification is selected, the output monitor displays Output 1 on the upper row and Output 2 on the lower row as a percentage (%) of the output value and a bar graph.

As the above, when OUT1 is highlighted, or OUT1 and OUT2 are both highlighted, this means that the controller is in the Manual mode (MAN=ON).

Under the manual mode, output value can be set using front key switches. For details, refer to "15-7 Setting Control Output".

## 14-2 Operations in Basic Screen

### (1) Switching the SV No.

You can switch the currently executing SV No. of the currently displayed channel by the  key, and set or change the currently executing SV value of the currently displayed channel by the ,  and  keys.

### (2) Output monitor screen

The output monitor displays the outputs of Control Output 1 (OUT1) and Control Output 2 (OUT2) as a percentage (%) of the output values as a bar graph.

In the Manual Output mode, outputs values can be set or changed by the ,  and  keys.

In a 2-output specification, select the output value of the side to be set or changed using the cursor displayed in front of the output name.

# 15 OPERATIONS DURING CONTROL

## 15-1 Monitoring Control

### (1) Basic screen

For flow of basic screen and operation, refer to "14-1 Flow of Basic Screen". The basic screen is "SV No., Output value display".

### (2) Output value display



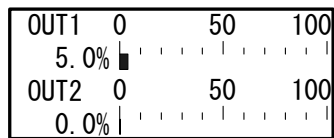

0-1

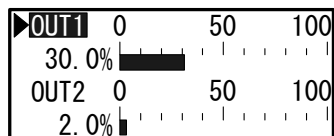

The output values of Control Output 1 (OUT1) and Control Output 2 (OUT2: option) are displayed on the upper and lower sections, respectively, as a % and a bar graph.

In the 1-output specification, OUT2 is not displayed.



During manual output (when OUT1 and/or OUT2 are highlighted), OUT1 or OUT2 can be selected by the  key, and output can be adjusted by operating the ,  or  key.

For details, see "15-7 Setting Control Output."

## 15-2 Switching the Execution SV No.

1. When you press the **[SV]** key in a screen display other than the basic screen, the basic screen is displayed, and the number of the SV No. blinks and can be changed.
2. When you press the **[SV]** key, the number of the SV No. is incremented and blinks, and can be changed.
3. The SV No. can be changed using the **[▲]** or **[▼]** key.  
Also, pressing the **[SV]** key increments the number of the SV No.
4. When the number of the SV No. is fixed and registered by the **[ENT]** key, the number stops blinking.

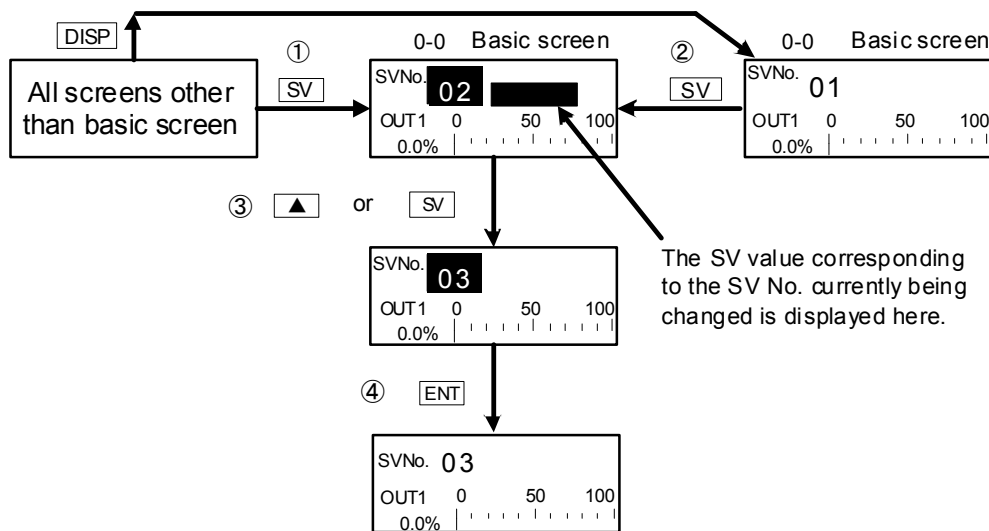

When SV No. switching is set to external switching (EXT\_SV assigned to DI7 and EXT indicator lit), the SV No. cannot be changed using the keys on the front panel of this device.

## 15-3 Setting the Execution SV No.

Follow the procedure below to set or change the SV No. currently being executed.

1. When you press the **[◀]**, **[▲]** or **[▼]** key in the basic screen (0-0), the smallest digit of the SV display blinks, and the SV No. can be set or changed.
2. Press the **[◀]** key to move the blinking section on the numerical value to the digit to be changed, and change the SV No. using the **[▲]** or **[▼]** key.

To set or change not the currently executing SV value but an already set SV value, see "9-1 Setting the SV Value."

## 15-4 Externally Switching the SV No.

When two or more target set values (SV) are used, selection of the execution SV No. can be switched by an external contact.

Only DI7 to DI10 can be set.

This function can be used only when the optional external I/O control function is installed.

When EXT\_SV is assigned to DI7, DI8 to DI10 automatically become the SV No. external switched assignments, and other functions can no longer be assigned.

5-3

DI5:	None
DI6:	None
DI7:	EXT_SV
DI8:	EXT_SV

Select the SV No. as shown in the table below and switch to this SV No. corresponding to the signal input of DI7 to DI10.

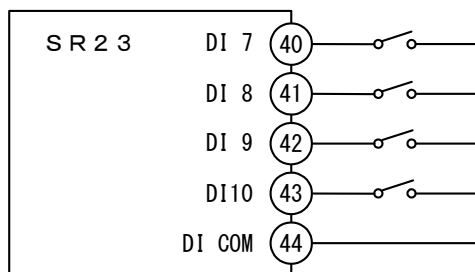

SV No. \ DI No.	1	2	3	4	5	6	7	8	9	10
DI 7	●		●		●		●		●	
DI 8		●	●			●	●			●
DI 9				●	●	●	●			
DI 10								●	●	●

●: Indicates that the switch is ON.

### Note

- ◆ When there is no input to DI, SV No.1 becomes the execution SV.
- ◆ When there is a DI input corresponding to 11 or more, SV No.10 becomes the execution SV.
- ◆ When switching is performed, for example, by a decimal switch, sometimes an SV No. other than the expected SV No. is switched to momentarily at the moment that the contact is switched. Set DI on this device so that it is switched within the response time (100 ms).



## 15-5 Auto Tuning

### (1) Executing and Stopping Auto Tuning

Select execution/stop of PID auto tuning (AT).

During execution of auto tuning, the optimum PID constants are calculated according to the limit cycle method, and those values are used to automatically perform control action. During execution of auto tuning, hunting caused by the limit cycle occurs near the SV value.

Hunting near the SV value can be prevented by setting the auto tuning point to perform auto tuning when the value leaves the SV value.

For details on setting this auto tuning point, see "10-10 Auto Tuning Point."

1-1

AT	<input checked="" type="checkbox"/>	OFF
MAN	:	OFF
STBY	:	OFF

Setting range    ON, OFF  
Initial value    OFF

Auto tuning is executed when AT is set to ON.

During execution of auto tuning, the AT LED indicator blinks, lights during auto tuning standby, and goes out when auto tuning ends or stops.

When "AT execution/stop switching" is assigned to DI, auto tuning can be executed by external contacts, however, "AT execution/stop" by front key switches is not possible.

For execution of auto tuning, the following conditions must be satisfied.

These conditions are common to both front panel keys and external switch input.

- ◆ The mode must not be the manual output (MAN) mode.
- ◆ Execution of ramp control must not be in progress.
- ◆ P must not be set to 0 (ON-OFF control).
- ◆ The mode must not be standby (STBY: ON, action stopped).
- ◆ Remote SV must not be in use.
- ◆ The mode must not be zone PID.
- ◆ The PV value must not be causing the scale over error.
- ◆ Self-tuning must not be set.

---

#### Note

- ◆ It is sometimes better to correct the PID obtained by auto tuning depending on the control target, control loop wasted time, and other factors.
  - ◆ To use the output limit, set the lower limit and higher limit values of the control output value before execution of auto tuning.
  - ◆ Auto tuning action is stopped in the following instances:
    - (1) When a scale over error occurs
    - (2) During a power failure
    - (3) When the ON or OFF time has exceeded about 200 minutes
    - (4) When the standby (STBY) mode is set
-

**(2) Selecting the PID tuning mode**

PID auto-tuning using the limit cycle method is the default tuning mode for Tuning.

8-1

Tuning <input checked="" type="checkbox"/> Auto Tuning
Hunting: 0.5%
AT Point: 0.0°C

Setting range	Auto Tuning, Self Tuning
Initial value	Auto Tuning

**15-6 Self Tuning**

Various restrictions are applied to use of self tuning.  
For details on self tuning, see "15-2 Tuning Functions."

Select self tuning at Tuning.

3-22

Tuning <input checked="" type="checkbox"/> Self Tuning
Hunting: 0.5%
AT Point: 0.0°C

Setting range	Auto Tuning, Self Tuning
Initial value	Auto Tuning

---



---

## Caution

- As the SR23 is a high-precision, high-function controller, use of the auto tuning (AT) function is recommended as optimum PID constants can be obtained more easily than by self tuning.
  - On the following types of control targets, set tuning sometimes does not function normally, inappropriate PID constants are calculated and set, and the optimum control result is not obtained. For this reason, do not use self tuning:
    - ◆ Control targets that cause cyclical external disturbance
    - ◆ Control target with extremely short or long dead band
    - ◆ When the measured value (PV value) contains noise and is unstable
  - For two output specification, the tuning mode is fixed to Auto Tuning.
- 
-

## 15-7 Setting Control Output

Select auto (AUTO)/manual (MAN) of control output.

Normally, operation is performed automatically. This item, however, is used to manually set the control output during trial operation, for example.

During manual output, the preset value continues to be output, and feedback control is not performed. Also, the MAN status lamp or status monitor blinks.

### (1) Switching auto/manual of Control Output

1-1		Setting range	ON, OFF
AT	: OFF	Initial value	OFF
MAN	▣ OFF		
STBY	: OFF		

The mode changes to the Manual Output mode when MAN (manual) is selected by the cursor and ON is selected and registered.

When "AT control output auto/manual switching" is assigned to DI, auto/manual switching can be executed by external contacts.

### (2) Output value

This operation can be executed on OUT1/OUT2 that are in the Manual Output mode.

When OUT1/OUT2 are displayed in reverse, this indicates that these outputs are in the Manual Output mode.

The output value and output bar graph for OUT2 are displayed in the case of the 2-output specification.

1. Press the **DISP** key to call up the basic screen.
2. Press the **SCRN** key to display the output monitor screen (0-1).
3. When the cursor (▣) is not at the target output, move the cursor using the **↶** key, and select OUT1 or OUT2 that is displayed in reverse.

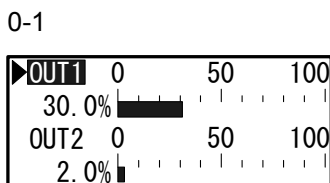

4. Increment/decrement the output value by the **◀**, **▼** or **▲** key.  
With manual output, values need not be fixed and registered by the **ENT** key.

### (3) MAN key operations

This device is provided with a key exclusively for manual output so that you can switch to the output monitor screen (0-1) by pressing the **MAN** key in any screen display. Output operations cannot be performed in this state.

#### ■ Simple operation

1. Press the **MAN** key to call up the output monitor screen.
2. Press the **▲** key or **▼** key while holding down the **MAN** or the **ENT** key. The letters **OUT1** are highlighted to indicate that manual output (MAN: ON) is switched to.
3. Set the **OUT1** output value by the **◀**, **▼** or **▲** key. Set the **OUT2** output value by the **↻** key to shift to **OUT2**, and then by the **◀**, **▼** or **▲** key.
4. Press the **▲** key or **▼** key again while holding down the **MAN** or the **ENT** key. The setting returns to auto (MAN: OFF).

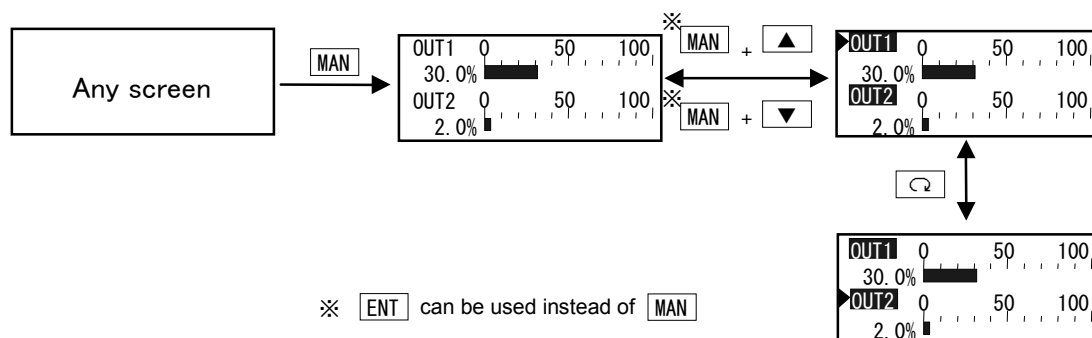

For manual execution, the following conditions must be satisfied.

These conditions are common to both front panel keys and external switch input.

- ◆ Execution of auto tuning must not be in progress (AT: ON).
- ◆ The mode must not be standby (STBY: ON).

#### Note

When this device is turned OFF with the Manual Mode set (MAN=ON) and turned ON again, this device starts up with the Manual Mode continued.

## 15-8 Control Standby (STBY)

This function is for setting control output, event output or external output (DO) to a standby state (stop), and standing by for input, etc. to stabilize before starting control. Analog output acts regardless of the execution/standby setting.

Control output in the Standby Mode becomes the preset output at standby (initial value 0%), and the STBY LED indicator blinks.

When "control execution/standby switching" is assigned to DI, execution/standby switching can be executed by external contacts.

1-1

AT	:	OFF
MAN	:	OFF
STBY	▣	OFF

Setting range OFF, ON

Initial value OFF

STBY=ON Control action is stopped, and control output becomes the preset output at standby (initial value 0%).

STBY=OFF Regular automatic control is performed.

For details on how to set output at standby, see "8-3 (2) Output at standby."

---

### Note

When this device is turned OFF with the Manual Mode set (STBY=ON) and turned ON again, this device starts up with the Standby Mode continued.

---

## 15-9 Pausing/Resuming Ramp Control (RAMP)

"Ramp control" is a function for not suddenly changing SV when it is switched but is a function for ensuring that SV changes according to a fixed ramp (rate-of-change). This function enables this device to be used as a simple programmable controller.

Ramp control can be paused, resumed and aborted during execution.

During execution of ramp control (RAMP: RUN), the RMP LED indicator blinks, and lights when ramp execution is paused (PAUSE).

1-2

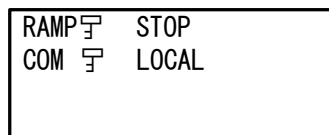

Setting range	RUN, PAUSE, QUICK
Initial value	STOP

**STOP** STOP indicates that the ramp control is not executed.

**PAUSE** When RAMP control is executing (RAMP: RUN), and set to PAUSE, ramp control is paused, and control changes to fixed-value control using the execution SV value at that time. The RMP LED indicator lights.

**RUN** Paused ramp control can be resumed by RAMP: RUN setting.

After ramp control is executed, the display changes to RAMP: RUN, the RMP LED indicator blinks, and the indicated SV No. changes towards to the target SV value.

Start ramp control by switching the execution SV No.

**QUICK** Aborts ramp control, and immediately switches to the SV value of the target SV No.

For details on setting ramp control, see "9-5 Setting the Ramp."

## 15-10 Tuning Functions

This section describes the PID constant tuning functions.

Adjustment of PID (P: proportional band, I: integral time, D: derivative time) that are used in PID control is generally referred to as "tuning."

The SR23 Series supports the following two PID constant tuning methods:

1. Auto tuning (AT)
2. Self tuning

### Caution

- As the SR23 is a high-precision, multi-function controller, use of the auto tuning (AT) function is recommended as optimum PID constants can be obtained more easily than by self tuning.
- On the following types of control targets, set tuning sometimes does not function normally, inappropriate PID constants are calculated and set, and the optimum control result is not obtained. For this reason, do not use self tuning:
  - ◆ Control targets that have cyclical external disturbance
  - ◆ Control target with extremely short or long dead band
  - ◆ When the measured value (PV value) contains noise and is unstable
- For two output specification, the tuning mode is fixed to Auto Tuning.

### 15-10-1 Auto tuning (AT)

#### ■ System operation in Auto tuning

SR23 auto tuning is performed by the limit cycle method.

By this method, the control output is turned ON/OFF, to measure the amplitude and dead band of the measured value (PV), and calculate the PID constants.

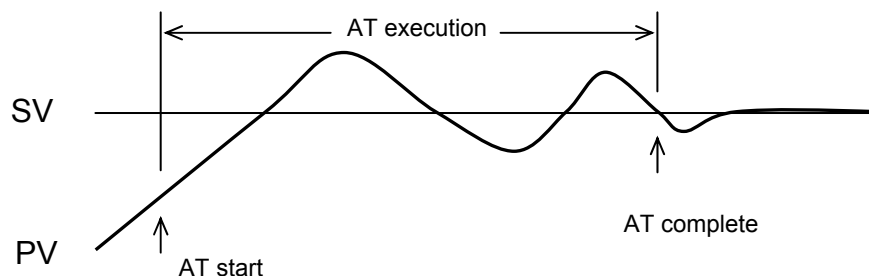

As the measured value is affected by the set value (SV), set auto tuning points (AT point) to prevent excessive measured values.

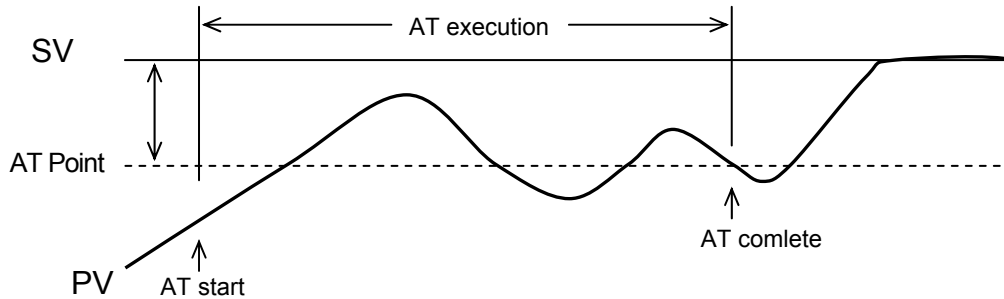

### ■Conditions for starting up Auto tuning

- ◆ When [Tuning : Auto Tuning] is selected in the tuning screen, and AT is set ON (by front panel keys DI input or communications)

### ■Conditions for not starting up Auto tuning

- ◆ When standby operation (STBY) is being executed
- ◆ When output is manual output (MAN)
- ◆ When remote SV control (REM) is being executed
- ◆ When ramp control (RMP) is being executed
- ◆ When P=OFF (ON-OFF control)
- ◆ When PV zone PID is set
- ◆ When the PV value causes a scale over (SO) error

### ■Canceling Auto tuning during execution

- ◆ AT is canceled by setting to OFF (by front panel keys, DI input, or communications)
- ◆ When 200 minutes is exceeded with the output value at the 0% or 100%
- ◆ During standby
- ◆ When the PV value causes a scale over (SO) error
- ◆ During a power outage

#### Note

- ◆ Auto tuning sometimes is not performed correctly when the measured value (PV) contains noise and is unstable. Either stabilize the measurement input, or use a PV filter, for example, to stabilize the measured value before executing auto tuning.
- ◆ When the output limiter is used, set the output limiter before execution of auto tuning. Note however, that control output operates between 0% to 100% (ON-OFF) regardless of the output limiter when output is contact output or SSR drive voltage output.
- ◆ With some control targets, optimum PID constants are sometimes not obtained. If this happens, correcting the PID constants obtained by auto tuning may provide better results.



## 15-10-2 Self tuning

Self tuning is a function provided for performing tuning more easily than auto tuning. Self tuning is executed after tuning conditions are automatically judged. Two methods are provided on the SR23 for self tuning:

1. Self tuning: step response (St)
2. Self tuning: hunting suppression (Hu)

These self tuning modes cannot be specified by users, as these are automatically selected by SR23.

### (1) Self tuning: by step response (St)

With self tuning by step response, timing is automatically performed by the step response method and PID constants are set by measuring fluctuations in the measured value (PV) when a fixed deviation and stable control output are being output, for example, when the power is turned ON, standby mode (STBY) is changed to execution (STBY OFF), or the setting value (SV) is changed.

#### ■Step response tuning

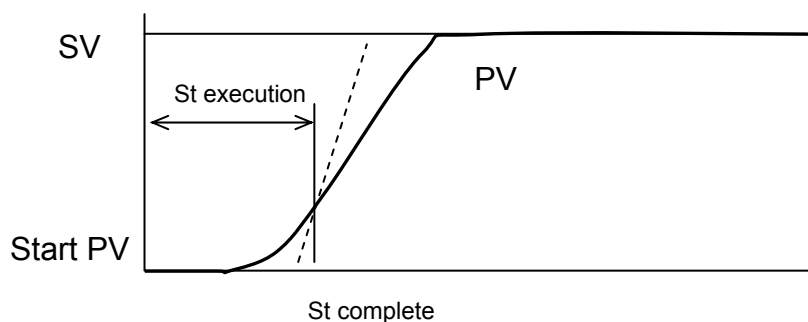

When self tuning by step response is started up, control computation is performed using the preset PID constants, and when tuning ends successfully, control computation is performed using the PID constants obtained and set by tuning.

Accordingly, when tuning is not to start up or is canceled, control computation will be continued using the PID constants set so far.

#### ■Conditions for starting up Self tuning

When [Tuning : Self Tuning] is selected in the tuning screen

- ◆ Immediately after power ON
- ◆ When standby (STBY) is changed to execution (STBY OFF)
- ◆ When the SV value is changed

#### ■Conditions for not starting up Self tuning

- ◆ When the controller is 2-output specification.
- ◆ When standby operation (STBY) operation is being executed.
- ◆ When output is manual output (MAN).
- ◆ When ramp control (RMP) is being executed.

- ◆ When remote SV control (REM) is being executed.
- ◆ When P = OFF (ON-OFF control)
- ◆ When the PV value causes a scale over (SO) error
- ◆ When zone PID is set
- ◆ When setting up the output rate-of-change limiter
- ◆ When step output (error between control output before and after startup) is 10% or less

### ■ Conditions for canceling Self tuning by the step response

When the following operations are performed during self tuning by the step response, or conditions are satisfied, self tuning is canceled, and control is continued using the PID constants that were previously set:

- ◆ When the control characteristics (Reverse/Direct) are changed
- ◆ When the output limiter is changed
- ◆ When the control output is changed
- \* As control is performed using the PID constants that were set when self tuning was set, when the proportional band is large, and the deviation between the set value and the measured value is small, the control output will immediately fluctuate. For this reason, tuning becomes more likely to be canceled.
- ◆ When 10 hours have elapsed after tuning is started
- ◆ When the measured value fluctuates due to noise, etc., and it is judged that computation by the step response method is abnormal

---

## Caution

- When the following conditions are not observed in self tuning by step response, accurate tuning results cannot be obtained, and inappropriate PID constants sometimes are calculated and set:
    - ◆ The control target and control loop must be operating correctly.
    - ◆ The measured value (PV) must be in a stable state when self tuning is started up. When measured values are fluctuating considerably, inappropriate PID constants may be calculated by executing self tuning.
    - ◆ The power of control terminals such as heaters must be ON when self tuning is started up.
  - If inappropriate PID constants are set, and stable control results cannot be obtained by the above conditions, perform the following to remedy this:
    - ◆ Correct the PID constants obtained by self tuning.
    - ◆ Execute auto tuning (AT).
-

## (2) Self tuning: by hunting suppression (Hu)

### ■ System operation in hunting suppression

Hunting suppression tuning returns the measured value (PV) towards the stable direction when measured value causes hunting due to changes in the conditions of the control target.

#### Hunting suppression tuning

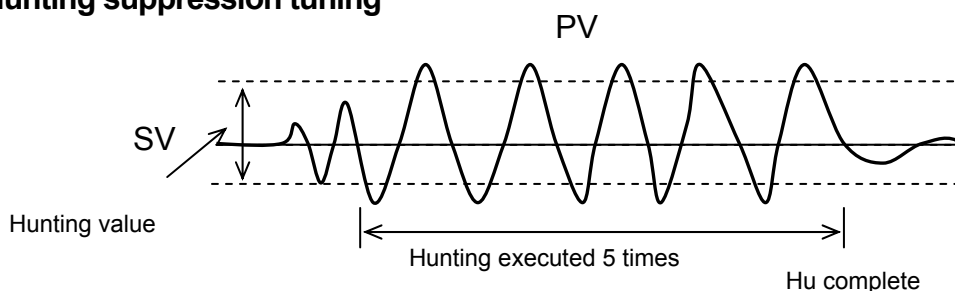

### ■ Conditions for starting up Self tuning

When [Tuning : Self Tuning] is selected in the tuning screen

- ◆ When the set value (SV) crosses ( $\pm 0.02\%$ FS or more) and fluctuates vertically
- ◆ When vertical fluctuation is repeated at a Hunting value or more set in the tuning screen

### ■ Conditions for not starting up Self tuning

- ◆ When the controller is 2-output specification.
- ◆ When standby operation (STBY) operation is being executed.
- ◆ When output is manual output (MAN).
- ◆ When ramp control (RMP) is being executed.
- ◆ When remote SV control (REM) is being executed.
- ◆ When P = OFF (ON-OFF control).
- ◆ When the PV value causes a scale over (SO) error.
- ◆ When zone PID is set.
- ◆ When the output rate-of-change limiter is being executed.
- ◆ During self tuning by step response.

### ■ Tuning standby conditions

When the following conditions occur, operation stands by for new startup conditions to be generated:

- ◆ When the current fluctuation width attenuates (gets smaller) to 25% or less from the previous fluctuation width
- ◆ When the 5th fluctuation width attenuates (gets smaller) to 25% or less from the initial fluctuation width
- ◆ When the PID constants are changed
- ◆ When the control characteristics (Reverse/Direct) are changed
- ◆ When the output limiter is changed

The aim of hunting suppression tuning when hunting occurs is to suppress hunting that occurs when the PID constants do not match the actual control target (e.g. small P, small I, large D).

As the aim is to suppress vibration, when vibration is caused by cyclic external disturbance, for example, the PID constants may be slightly corrected (e.g. larger P, larger I), which might result in increased vibration.

If this happens, the PID constants must be adjusted by the following methods:

- ◆ Reduce cyclic external disturbance.
- ◆ Set up the PID constants by auto tuning (AT).

This page left intentionally blank.

## 16 ERROR DISPLAYS

### 16-1 Operation Check Abnormalities at Power ON

This device displays the following error codes on the PV display when an error is detected.

Display	Cause	
<i>E - r o ñ</i>	ROM error	In any of the states shown on the left, all outputs turn OFF or become 0%.
<i>E - r A ñ</i>	RAM error	
<i>E - E E P</i>	EEPROM error	
<i>E - A d 1</i>	Input 1 A/D error	
<i>E - S P c</i>	Hardware error	

### Request

- ◆ If any of the messages shown in the above table is displayed, repair or replacement may be required. Immediately turn the power OFF, and contact your dealer.

### 16-2 PV Input Abnormalities

When a PV input-related abnormality is detected during execution of control on this device, the following error codes are displayed on the PV display.

Display	Cause
<i>Sc . LL</i>	The PV value exceeded the measuring range lower limit (-10%FS).
<i>Sc . HH</i>	The PV value exceeded the measuring range higher limit (+110%FS).
	RTD-A burnout
	Thermocouple burnout
<i>b - - -</i>	One or two RTD-B burnout, or, all leads of the RTDs burnout Action of this device in this case is PV moving excessively towards the higher limit.
<i>U . LL</i>	Reference junction compensation (-20°C) is at the lower limit. (thermocouple input)
<i>U . HH</i>	Reference junction compensation (+80°C) is at the higher limit. (thermocouple input)

### 16-3 REM Input Abnormalities

When an abnormality is detected in the REM input during execution of REM SV on this device, the following error codes are displayed on the PV display.

Display	Cause
<i>rE.LL</i>	REM input exceeds the input range lower limit.
<i>rE.HH</i>	REM input exceeds the input range higher limit.

## Request

- ◆ Check input when the above messages are displayed. If the input is not in error and there is another probable cause, contact your dealer.

### 16-4 Heater Current Abnormalities (option)

When a heater current abnormality is detected during execution of control on this device the following error codes are displayed on the LCD.

Display	Cause
<i>Hb.HH</i>	The heater current exceeds 55.0A.

## 17 LIST OF PARAMETERS

This chapter lists all of the parameters used by the SR23.

Parameters that cannot be set by the user are not listed.

Display symbol	Indicates the parameter symbol displayed on the LCD screen.
Description of function	Indicates the display or setup details.
Setting range	Indicates the range of parameters or numerical values that can be set.
Initial value	Indicates the factory setting. (excluding instances where this device is shipped with values customized to customer specified values)
Lock	Number indicates the level at which key lock is valid.

\* Indicates a parameter that may be initializes when one of a range setting, digit setting or PV scaling setting has been changed.

Parameters marked by \* may need to be confirmed again when the above settings have been change.

### 17-1 Basic Screen Group (group 0)

Display Symbol	Description of Function	Setting Range	Initial Value	Lock
SV No.	Target set value No.	1 to 10, REM	1	2
OUT1	OUT1 output value	0.0 to 100.0 %	---	1
OUT2	OUT2 output value	0.0 to 100.0 %	---	1

### 17-2 Execution Screen Group (group 1)

Display Symbol	Description of Function	Setting Range	Initial Value	Lock
AT	Execution of auto tuning	OFF : Stop auto tuning ON : Execute auto tuning	OFF	2
MAN	Switching of manual output action	OFF : Automatic control ON : Manual output	OFF	2
STBY	Standby switching	OFF : Execute ON : Standby	OFF	2
RAMP	Ramp control	STOP : Execution OFF PAUSE : Execution paused RUN : Execution continued	STOP	2
COM	Communication state	LOCAL : Set on unit COMM : Set by communication	LOCAL	2



### 17-3 SV Setup Screen Group (group 2)

Display Symbol		Description of Function	Setting Range	Initial Value	Lock
SV1	*	Target set value 1	Within setting limiter range	0 digit	3
SV2	*	Target set value 2			
SV3	*	Target set value 3			
SV4	*	Target set value 4			
SV5	*	Target set value 5			
SV6	*	Target set value 6			
SV7	*	Target set value 7			
SV8	*	Target set value 8			
SV9	*	Target set value 9			
SV10	*	Target set value 10			
REM		Remote monitor	Within remote scale range (display only)		
SV Limit_L	*	Target set value lower limit value limiter	Within measuring range	Measuring range lower limit value	1
SV Limit_H	*	Target set value upper limit value limiter	Within measuring range	Measuring range upper limit value	1
REM Track		Remote tracking	NO YES	NO	1
REM Mode	*	Remote mode	RSV : Remote SV RT : Remote ratio	RSV	1
REM Ratio	*	Remote ratio	0.001 to 30.000	1.000	1
REM Bias	*	Remote bias	-10000 to 10000 digit	0 digit	1
REM Filt		Remote filter	OFF, 1 to 300 Sec	OFF	1
REM Sc_L	*	Lower limit side remote scale	Within measuring range	Measuring range lower limit value	1
REM Sc_H	*	Higher limit side remote scale	Within measuring range	Measuring range higher limit value	1
REM PID		Remote SV PID No.	1 to 10	1	1
REM SQ. Root		Remote square root extraction operation	OFF ON	OFF	1
REM Low Cut		Remote square root extraction operation low cut	0.0 to 5.0%	1.0%	1
RAMP Up	*	Ascending ramp value	OFF, 1 to 10000 digit	OFF	1
RAMP Down	*	Descending ramp value	OFF, 1 to 10000 digit	OFF	1
RAMP Unit		Ramp unit	/Sec/Min	/Sec	1
RAMP Ratio		Ramp ratio	/1 /10	/1	1

## 17-4 PID Screen Group (group 3)

Display Symbol			Description of Function	Setting Range	Initial Value	Lock	
PID01	OUT1	P	Proportional band	OFF, 0.1 to 999.9 %	3.0 %	1	
PID02		I	Integral time	OFF, 1 to 6000 sec	120 sec	1	
PID03		D	Derivative time	OFF, 1 to 3600 sec	30 sec	1	
PID04		DF *	Hysteresis	1 to 9999 digit	20 digit	1	
PID05		MR	Manual reset		-50.0 to 50.0 %	0.0 % (1-output specification)	1
PID06						-50.0 % (2-output specification)	
PID07		OUT2	SF	Set value function	0.00 to 1.00	0.40	1
PID08			ZN *	PID zone	Within measuring range	0 digit	1
PID09			P	Proportional band	OFF, 0.1 to 999.9 %	3.0 %	1
PID10			I	Integral time	OFF, 1 to 6000 sec	120 sec	1
		D	Derivative time	OFF, 1 to 3600 sec	30 sec	1	
		DF *	Hysteresis	1 to 9999 digit	20 digit	1	
		MR	Manual reset	-50.0 to 50.0 %	0.0 % (1-output specification)	1	
					-50.0 % (2-output specification)		
		DB *	Dead band	-19999 to 20000 digit	0 digit	1	
		SF	Set value function	0.00 to 1.00	0.40	1	
		ZN *	PID zone	Within measuring range	0 digit	1	
	OUT1L		Output limit lower limit value (OUT1)	0.0 to 99.9 %	0.0 %	1	
	OUT1H		Output limit higher limit value (OUT1)	0.1 to 100.0 %	100.0 %	1	
	OUT2L		Output limit lower limit value (OUT2)	0.0 to 99.9 %	0.0 %	1	
	OUT2H		Output limit higher limit value (OUT2)	0.1 to 100.0 %	100.0 %	1	
Zone	PID1		OUT1 zone PID mode	OFF SV : SV zone selection PV : PV zone selection	OFF	1	
	HYS1 *		OUT1 zone hysteresis	0 to 10000 digit	20 digit	1	
REM PID			Remote SV PID No.	1 to 10	1	1	
Tuning			Tuning mode	Auto Tuning Self Tuning	Auto Tuning	1	
Hunting			Hunting	0.1 to 100.0%	0.5%	1	
AT Point		*	Auto-tuning point	0 to 10000 digit	0 digit	1	

### 17-5 EVENT/DO Screen Group (group 4)

Display Symbol		Description of Function	Setting Range	Initial Value	Lock
EV1 EV2 EV3 DO1 DO2 DO3 DO4 DO5 DO6 DO7 DO8 DO9	SP*	Operation value	Within measuring range (PV, SV)  -25000 to 25000 digit (DEV Hi, DEV Low)  0 to 25000 digit (DEV Out, DEV In)	DEV Hi : 25000 digit DEV Low : -25000 digit DEV Out : 25000 digit DEV In : 25000 digit PV Hi : Measuring range higher limit value PV Low: Measuring range lower limit value SV Hi : Higher limit value of SV SV Low : Lower limit value of SV	2
DO10 DO11 DO12 DO13	MD	Operation mode	None : No action DEV Hi : Higher limit deviation action DEV Low: Lower limit deviation action DEV Out: Outside higher/lower limit deviation action DEV In : Inside higher/lower limit deviation action PV Hi : PV higher limit absolute value action PV Low : PV lower limit absolute value action SV Hi : SV higher limit absolute value action SV Low : SV lower limit absolute value action AT : Auto tuning execution in progress MAN : Manual action in progress REM : Remote action in progress RMP : Ramp control execution in progress STBY : Control action not in progress SO : PV, REM input scale over PV SO : PV scale over REM SO : REM scale over LOGIC : Logic operation output (EV1 to EV3, DO1 to DO5) (*1 *2) Direct : Direct output (DO6 to DO13) (*3) HBA : Heater break alarm output (*4) HLA : Heater loop alarm output (*4)	EV1: DEV Hi EV2: DEV Low EV3: None DO1 to DO13: None (*5)	1

Display Symbol		Description of Function	Setting Range	Initial Value	Lock
EV1 EV2	ACT	Output characteristics	N.O.: Normally open N.C.: Normally closed	N.O.	1
EV3 DO1	DF*	Hysteresis	1 to 9999 digit	20 digit	1
DO2 DO3 DO4 DO5 DO6 DO7 DO8	IH	Standby action	OFF : None 1 : At power ON or at STBY ON -> OFF 2 : At power ON, at STBY ON -> OFF or SV change 3 : At input error	OFF	1
DO9	DLY	Delay time	OFF, 1 to 9999 Sec	OFF	1
DO10 DO11 DO12 DO13	STEV	Event output at standby	OFF ON	OFF	1
EV1 EV2 EV3	Log MD	Logic operation mode	AND OR XOR	AND	1
DO1	SRC1	Logic operation source 1	None, DI1 to DI10	None	1
DO2 DO3	SRC2	Logic operation source 2		None	1
	Gate1	Logic operation gate source 1	BUF INV FF	BUF	1
	Gate2	Logic operation gate source 2		BUF	1
DO4 DO5	Timer	Timer (action time)	OFF, 1 to 5000 Sec	OFF	1
	Counter	Counter (action time)	OFF, 1 to 5000	OFF	1
	SRC	Logic operation generation source selection	DI1 to DI10	None	1
	Log_MD	Logic operation mode	Timer Counter	Timer	1

\*1 Logic operation (AND, OR, XOR) can be assigned only to LOGIC EV1 to EV3, and DO1 to DO3.

\*2 Logic operation (Timer, Counter) can be assigned only to DO4 and DO5.

\*3 Direct output can be assigned only to DO6 to DO13 with communication interface option.

\*4 This function is optional and is not displayed when it is not installed.

\*5 DO6 to DO13 are optional and not displayed when they are not installed.

## 17-6 DI/Options Screen Group (group 5)

Display Symbol	Description of Function	Setting Range	Initial Value	Lock
DI1	DI1 assignment	None : No action (factory default)	None	1
DI2	DI2 assignment	MAN : Switching of control output between auto/manual		
DI3	DI3 assignment	REM : Switching of REM SV/LOC SV setting.		
DI4	DI4 assignment	AT : Switching of AT execution/stop		
DI5	DI5 assignment	STBY : Switching of control execution/standby		
DI6	DI6 assignment	ACT : Switching of direct/reverse action on Output 1 characteristics		
DI7	DI7 assignment	ACT2 : Switching of direct/reverse action on Output 2 characteristics		
DI8	DI8 assignment	Pause : Switching of pause/resume of ramp control		
DI9	DI9 assignment	Logic : Logic operation		
DI10	DI10 assignment	EXT_SV : External switching of SV No. Only DI7 can be set (assigned to DI7 to DI10).		
Ao1 Ao2	Analog output type assignment	PV : Measured value SV : Set value DEV : Deviation value OUT1 : Control Output 1 OUT2 : Control Output 2	PV (Ao1) SV (Ao2)	1
	_L * Analog output lower limit scaling	PV, SV : Within setting range DEV : -100.0 to 100.0% OUT1, OUT2 : 0.0 to 100.0%	Setting range lower limit value	1
	_H * Analog output higher limit scaling		Setting range higher limit value	1
Heater	Heater current value monitor	0.0 to 55.0 A display only	---	---
HB	Heater current detection selection	OUT1 OUT2	OUT1	1
HBM	Heater break alarm mode	Lock Real	Lock	1
HBA	Heater break alarm current value	OFF, 0.1 to 50.0 A	OFF	1
HLA	Heater loop alarm current value	OFF, 0.1 to 50.0 A	OFF	1

## 17-7 Communication (group 5)

Display Symbol	Description of Function	Setting Range	Initial Value	Lock
PROT	Communication protocol	SHIMADEN : Shimaden MOD_ASC : Modbus ASCII MOD_RTU : Modbus RTU	SHIMADEN	1
ADDR	Device No.	1 to 98	1	1
BPS	Communication speed	2400 4800 9600 19200	9600	1
MEM	Memory mode	EEP RAM R_E	EEP	1
DATA	Data length	7 8	7	1
PARI	Parity	EVEN ODD NONE	EVEN	1
STOP	Stop bit	1 2	1	1
DELY	Delay time	1 to 50 msec	10 msec	1
CTRL (*1)	Control	STX_ETX_CR STX_ETX_CRLF @ : CR	STX_ETX_CR	1
BCC (*1)	Checksum	ADD ADD_two's cmp XOR None	ADD	1

\*1: SHIMADEN standard protocol only

Note DI5 to DI10 and Ao1MD to BCC are optional and are not displayed when they are not installed.

## 17-8 Control Output Screen Group (group 6)

Display Symbol		Description of Function	Setting Range	Initial Value	Lock
OUT1	ACT	Output characteristics	Reverse: Reverse characteristics Direct : Direct characteristics	Reverse	1
	STBY	Output at standby	0.0 to 100.0 %	0.0 %	1
	ERR	Output at error	0.0 to 100.0 %	0.0 %	1
	CYC	Proportional cycle time	1 to 120 s	Contact (Y) : 30 s SSR (P) : 3 s	1
OUT2 (*1)	ACT	Output characteristics	Reverse : Reverse characteristics Direct : Direct characteristics	Direct	1
	STBY	Output at standby	0.0 to 100.0 %	0.0 %	1
	ERR	Output at error	0.0 to 100.0 %	0.0 %	1
	CYC	Proportional cycle time	1 to 120 s	Contact (Y) : 30 s SSR (P) : 3 s	1
Rate Limiter					
	OUT1	Output 1 rate-of-change limiter	OFF, 0.1 to 100.0 %/s	OFF	1
	OUT2 (*1)	Output 2 rate-of-change limiter	OFF, 0.1 to 100.0 %/s	OFF	1

\*1 Control output 2 is optional and is not displayed when it is not installed.

## 17-9 Unit/Range Screen Group (group 7)

Display Symbol	Description of Function	Setting Range	Initial Value	Lock
PV Bias *	PV bias	-10000 to 10000 digit	0 digit	1
PV Filter	PV ramp bias	OFF, 1 to 100 s	OFF	1
PV Slope * (*1)	PV filter	0.500 to 1.500	1.000	1
RANGE	Measuring range	01 to 19 TC 31 to 44 RTD Pt100 45 to 58 RTD old JIS JPt100 71 to 77 Voltage (mV) 81 to 87 Voltage (V)	06	1
Sc_L *	Input lower limit side scale	-19999 to 29990 digit	0 digit	1
Sc_H *	Input higher limit side scale	-19989 to 30000 digit	1000 digit	1
UNIT *	Measurement unit	RTD, TC: °C, °F  I/V: %, °C, °F, None	RTC,TC: °C  I/V: %	1
DP *	Decimal point position	XXXXX. XXXX.X XXX.XX XX.XXX X.XXXX	XXXX.X	1
Figure * (*2)	Selection of number of digits past decimal point	Normal Short	Normal	1
CJ (*3)	Cold junction compensation	Internal External	Internal	1
SQ. Root * (*4)	Square root extraction operation (at linear input)	OFF ON	OFF	1
Low Cut (*5)	Square root extraction operation low cut	0.0 to 5.0 %	1.0 %	1
PMD (*4)	Linearizer operation mode	OFF ON	OFF	1
A1 to A11 (*4)	Linearizer approximation input	-5.0 to 105.0 %	0.00 %	1
B1 to B11 (*4)	Linearizer approximation output	-5.0 to 105.0 %	0.00 %	1

\*1 This screen is not displayed in the case of RTD and TC input.

\*2 This screen is not displayed in the case of voltage and current input.

\*3 This screen is displayed only in the case of TC input.

\*4 This screen is displayed only in the case of voltage and current input.

\*5 This screen is displayed only in the case of "square root function = ON".



**17-10 Lock, etc Screen Group (group 8)**

<b>Display Symbol</b>	<b>Description of Function</b>	<b>Setting Range</b>	<b>Initial Value</b>	<b>Lock</b>
KLOCK	Key lock	OFF : Release LOCK1: Other than SV, CONTROL LOCK2: Other than SV LOCK3: All	OFF	/
OUTPUT	Number of outputs	Single Dual	1-output: Single 2-output: Dual	1
IR COM	Infrared communications	ON : Enabled OFF : Disabled	ON	1

# 18 PARAMETER SETUP RECORD SHEETS

Lots of parameters are set on this device before use.

Users will find these sheets will come in handy to restore a system in the event of a malfunction, for example, if they keep a detailed record of the product model No. they are using and the values set on this device.

We recommend that you fully utilize these record sheets by making a blank copy of these tables and entering the required values on the copied record sheet.

## 18-1 Product Model Code

<b>SR23-</b>	<b>S</b>	<input type="checkbox"/>	<input type="checkbox"/>	<b>-</b>	<input type="checkbox"/>	<input type="checkbox"/>	<input type="checkbox"/>	<input type="checkbox"/>	<input type="checkbox"/>

## 18-2 SV Parameters

SV No.	Set Value
1	
2	
3	
4	
5	
6	
7	
8	
9	
10	

Item	Set Value
SV Limit_L	
SV Limit_H	
REM Bias	
REM Filter	
REM Sc_L	
REM Sc_H	
REM Track	
REM Mode	
REM Ratio	
REM SQ.Root	
REM Low Cut	
REM PID	
RMP UP	
RMP Down	
RMP Unit	
RMP Ratio	

### 18-3 PID Parameters

#### OUT1

PID No.	P	I	D	DF	MR	SF	Zone	OUT1L	OUT1H
01									
02									
03									
04									
05									
06									
07									
08									
09									
10									

#### OUT2

PID No.	P	I	D	DF	DB	SF	Zone	OUT2L	OUT2H
1									
2									
3									
4									
5									
6									
7									
8									
9									
10									

#### Zone PID

Item	Set Value
Zone PID1	
Zone HYS1	

#### Tuning

Item	Set Value
Tuning	
Hunting	
AT Point	

**18-4 EVENT/DO Parameters**

Item	EV1	EV2	EV3	DO1	DO2	DO3
SP						
MD						
ACT						
DF						
IH						
DLY						
STEV						
Log MD						
SRC1						
GATE1						
SRC2						
GATE2						

Item	DO4	DO5	DO6	DO7	DO8	DO9
SP						
MD						
ACT						
DF						
IH						
DLY						
STEV						
Log MD			---	---	---	---
SRC			---	---	---	---
Timer /Counter			---	---	---	---

Item	DO10	DO11	DO12	DO13
SP				
MD				
ACT				
DF				
IH				
DLY				
STEV				

**18-5 DI/Options Parameters**

Item	Set Value
DI1	
DI2	
DI3	
DI4	
DI5	
DI6	
DI7	
DI8	
DI9	
DI10	
Ao1MD	
Ao1 L	
Ao1 H	
Ao2MD	
Ao2 L	
Ao2 H	

Item	Set Value
HBA	
HLA	
HBM	
HB	
COM PROT	
ADDR	
BPS	
MEM	
DATA	
PARI	
STOP	
DELY	
CTRL	
BCC	

**18-6 Control Output Parameters**

Item	OUT1	OUT2
ACT		
STBY		
ERR		
CYC		
Rate Limiter		

## 18-7 Unit Measuring Range Parameters

### Input settings

Item	INPUT1
PV Bias	
PV Filter	
PV Slope	
RANGE	
Sc_L	
Sc_H	
UNIT	
DP	
Fig	
CJ	
SQ. Root	
Low Cut	
PMD	

### PMD set values

PMD No.	Set Value		
	n	An	Bn
1			
2			
3			
4			
5			
6			
7			
8			
9			
10			
11			

**18-8 Lock, etc. Parameters**

<b>Item</b>	<b>Set Value</b>
KLOCK	
OUTPUT	
IR COM	

# 19 SPECIFICATIONS

## 19-1 Display

- ◆ **LED display**      Measured value (PV) :7-segment red LED 5 digits, height of characters 16 mm  
Set value (SV) :7-segment green LED 5 digits, height of characters 11 mm
- ◆ **LCD display**      SV No., OUT% graph, control output value, various parameter displays  
128 x 32 dot matrix liquid crystal display with yellow-green LED backlight
- ◆ **Action display lamps**  
17 action statuses display. Light on or blinking when status is enabled
 

STBY	Green	Blinks when control output is set to standby (STBY=ON)
RMP	Green	Blinks during execution of ramp control, and lights during ramp control is paused
MAN	Green	Blinks when control output is set to manual operation
REM	Green	Lights when remote setting (REM) is set in SV No. selection
EV1 to EV3	Orange	Lights when each EV acts
DO1 to DO5	Orange	Lights when each DO acts
EXT	Green	Lights when SV No. can be selected by external switch
COM	Green	Lights when communication mode is ON
AT	Green	Blinks during execution of auto tuning or lights during holding of auto tuning
OUT1	Green	Control output (1-output side)
OUT2	Green	Control output (2-output side)
- ◆ **Display accuracy**     $\pm (0.1\% + 1\text{digit})$  of measuring range (See Measuring Range Code Table for individual ranges.)
 

TC input	$\pm (0.1\% \text{ FS} + 1^\circ\text{C})$
Pt input	$\pm (0.1\% \text{ FS} + 0.1^\circ\text{C})$
mV, V input	$\pm (0.1\% \text{ FS} + 1 \text{ digit})$
mA input	Depends on accuracy of externally attached resistor (When $\pm 0.1\% \text{ FS}$ accuracy is required, specify when ordering)
- ◆ **Temperature range for maintaining display accuracy**  
23°C±5°C
- ◆ **Display resolution**    0.0001, 0.001, 0.01, 0.1, 1 (differs depending on measuring range)
- ◆ **Sampling cycle**        0.1 seconds (100 msec)



## 19-2 Setting

- ◆ **Local setting** By 10 front panel key switches
  - Setting range Same as the measuring range
  - Multi-SV value setting Up to 10 points (SV1 to SV10) settable
  - Multi-SV value selection Front panel key switches or external control input (binary code)  
10 external control inputs (DI) (optional) can be selected
- ◆ **Remote setting** By external analog signals, not insulated (standard)/insulated (option)  
Remote setting is alternative of heater break alarm
  - Setting accuracy  $\pm(0.1\% \text{ FS} + 1 \text{ digit})$
  - Setting signal 0 to 10V, 1 to 5V, 4 to 20 mA DC (selectable from code selection table)
  - Sampling cycle 0.2 seconds (200 msec)
  - Remote scaling Possible within measuring range (reverse scaling possible)
  - Remote bias  $\pm 10000$  digit
  - Remote filter OFF, 1 to 300 seconds
- ◆ **Higher/lower limit setting limiter** Any value set within measuring range (lower limit < higher limit)
  - Remote square root Low cut range 0.0 to 5.0% FS (at mV, V)
  - Remote ratio 0.001 to 30.000
  - Local/remote switching Front panel key switches or external control input
  - Direct tracking function Remote set value switchable to local set value by bumpless transfers
- ◆ **Ramp control** Increment/decrement ramp control
  - Ramp value setting range Ascending/descending individual setting  
OFF, 1 to 10000 digit /minutes or seconds (when multiplier = 1)  
OFF, 0.1 to 1000.0 digit /minutes or seconds (when multiplier = 0.1)
  - Ramp unit time digit/seconds, digit/minutes
  - Ramp unit multiplier x 1, x 0.1

## 19-3 Input

- ◆ **Universal-input, multi-range** Thermocouple input, RTD input, voltage input (mV, V), current input (mA),
- ◆ **Thermocouple (TC) input type**
  - B, R, S, K, E, J, T, N, PLII, PR40-20, WRe5-26, {L, U (DIN43710) }
  - AuFe-Cr (Kelvin scale).
  - For details, see Measuring Range Code Table
  - Display range  $\pm 10\%$  of measuring range
  - Allowable range of external resistance 100 $\Omega$  max.
  - Input resistance Approx. 500 k $\Omega$
  - Cold junction compensation
    - Selectable between internal and external cold junction compensation
  - Internal cold junction compensation accuracy  $\pm 1^\circ\text{C}$  (in range of 18 to 28 $^\circ\text{C}$ )
  - Burnout functions Standard feature (up scale)
- ◆ **RTD input type** JIS Pt100 /JPt100 3-wire type. For details, see Measuring Range Code Table
  - Display range  $\pm 10\%$  of measuring range (not lower than -273.15 $^\circ\text{C}$ )
  - Lead wire tolerance 10 $\Omega$  max. per wire
  - Amperage Approx. 1.1mA
- ◆ **Voltage (mV, V) input type**
  - 10 to 10, 0 to 10, 0 to 20, 0 to 50, 10 to 50, 0 to 100, -100 to 100 mV
  - 1 to 1, 0 to 1, 0 to 2, 0 to 5, 1 to 5, 0 to 10, -10 to 10 V
  - Universal-input, programmable scaling
  - For details, see Measuring Range Code Table
  - Input resistance Approx. 500 k $\Omega$ .
- ◆ **Current (mA)**
  - Input type 4 to 20, 0 to 20 mA: Universal-input and programmable scaling by receiving resistance to 0 to 5, 1 to 5 V inputs
  - Receiving resistance 250 $\Omega$  by external resistance
- ◆ **Common functions**
  - Sampling cycle 0.1 seconds (100 msec)
  - PV bias  $\pm 10000$  digit
  - PV slope Input value x 0.500 to 1.500
  - PV filter OFF, 1 to 100 seconds
- ◆ **Input operation** Possible with voltage or current input
  - Square root extraction operation
    - Low cut range 0.0 to 5.0% FS
  - Linearizer approximation
    - Number of input points: 11
- ◆ **Isolation**
  - Insulated between input and DI input, or input and various outputs
  - Not insulated between input and the system, input and remote input, or input and CT input

## 19-4 Control

- ◆ **Control output** 1-output specification, 2-output specification
- ◆ **Control system (common to Control Output 1 and 2)**
  - Multi-PID W/ auto/self tuning function, Expert PID control  
By PID Nos.01 to 10 (10 types)
  - Zone PID Individual PID set on each SV No. (and remote SV)
  - Proportional band (P) Selectable between individual PID and zone PID (max. 10 zones)  
OFF, 0.1 to 999.9% (OFF: ON-OFF action)
  - Integral time (I) OFF, 1 to 6000 seconds (OFF: P or PD control)
  - Derivative time (D) OFF, 1 to 3600 seconds (OFF: P or PI control)
  - Manual reset (MR) -50.0 to 50.0% (Control Output 1, available when I = OFF)
  - Dead band (DB) -19999 to 20000 digit (Control Output 2 in 2-output specification)
  - Hysteresis (DF) 1 to 9999 digit (Effective when P=OFF)
  - Proportional cycle 1 to 120 seconds (at contact or SSR drive voltage output)
- ◆ **Control output type/rating (common to Control Outputs 1 and 2)**
  - Y: Contact 1c, Contact rating: 240 V AC, 2.5 A/resistive load, 1A/ inductive load
  - I: Current 4 to 20 mA DC, Load resistance: 600Ω max.
  - P: SSR drive voltage 12 V±1.5 V DC, Load current: 30 mA max.
  - V: Voltage 0 to 10 V DC, Load current: 2 mA max.
- Output accuracy ±0.5% FS (5 to 100% output/within accuracy maintaining temperature range)
- Resolution Approx. 1/14000 (during current or voltage output)
- ◆ **Operation/output update cycle** 0.1 seconds (100 msec)
- ◆ **Control output characteristics** Reverse (for heating)/Direct (for cooling), Control Outputs 1 and 2 set individually (heating/cooling, 2-stage heating/2-stage cooling selectable in 2-output specification)
- ◆ **Higher/lower output limiter setting range** Higher limit/lower limit (set individually for each PID No.)
- Setting range 0.0 to 100.0% (lower limit < higher limit)
- ◆ **Output rate-of-change limiter** OFF, 0.1 to 100.0%/seconds (set individually for Control Outputs 1 and 2)
- ◆ **Control output at error** 0.0 to 100.0% (set individually for Control Outputs 1 and 2)
- ◆ **Control output at standby** 0.0 to 100.0% (set individually for Control Outputs 1 and 2)
- ◆ **Manual control**
  - Auto/manual switching Balanceless/bumpless transfers (simultaneous for Control Outputs 1 and 2)
  - Output setting range 0.0 to 100.0% set individually for Control Outputs 1 and 2
  - Setting resolution 0.1%
- ◆ **Isolation** Insulated between Control Output and the system  
Not insulated between Control Outputs

## 19-5 Event Output

- ◆ **Number of outputs** Total 3: EV1 to EV3
- ◆ **Output rating** 240 V AC/1.0A resistive load common to contact outputs (normally open contacts)
- ◆ **Output update cycle** 0.1 seconds (100 msec)
- ◆ **Setting/selection** Individual setting (individual output), selectable from 20 types (to designate output)

### Output types

1) None	No action (no assignment)
2) DEV Hi	Higher limit deviation alarm
3) DEV Low	Lower limit deviation alarm
4) DEV Out	Outside higher/lower limit deviation alarm
5) DEV In	Inside higher/lower limit deviation alarm
6) PV Hi	PV higher limit alarm
7) PV Low	PV lower limit alarm
8) SV Hi	SV higher limit alarm
9) SV Low	SV lower limit alarm
10) AT	ON during execution of auto tuning
11) MAN	ON during manual control operation
12) REM	ON while remote SV is in action
13) RMP	ON while ramp control is in action
14) STBY	ON while control is out of action
15) SO	ON when PV and REM scale over error occurs
16) PV SO	ON when PV scale over error occurs
17) REM SO	ON when REM scale over error occurs
18) LOGIC	ON during logic operation output by DI or communication
19) Direct	ON during Direct output by communication
20) HBA	ON during heater break alarm action
21) HLA	ON during heater loop alarm action

Direct cannot be set for events, but for DOs.

- ◆ **Setting range**

DEV Hi, Low	-25000 to 25000 digit
DEV Out, In	0 to 25000 digit
PV Hi, Low	Within measuring range
SV Hi, Low	Within SV setting range
- Hysteresis 1 to 9999 digit (when DEV, PV or SV is selected)
- Action delay time OFF, 1 to 9999 seconds (when DEV, PV or SV is selected)
- Standby action Selectable from 3 types (when DEV, PV or SV is selected)
  - OFF, no standby action
  - 1) At power ON, or at STBY ON→ OFF
  - 2) At power ON, at STBY ON→ OFF, or at execution SV is changed
  - 3) At input error (SO), when action is OFF

### Output characteristics switching

Selectable between normally open and normally closed

- ◆ **Isolation** Insulated between alarm output and various I/O, or alarm output and the system

## 19-6 External Control Output (DO)

- ◆ **Number of outputs** 13, 9, or 5 points in total: standard 5 and 8 or 4 can be added optionally
  - DO1 to DO3 Darlington output 3 points
  - DO4 to DO5 Open collector output 2 points
  - DO6 to DO9 Open collector output 4 points (optional)
  - DO10 to DO13 Open collector output 4 points (optional)
- ◆ **Output rating** Open collector output 24 V DC/8 mA max., ON voltage 0.8 V or lower  
Darlington output 24 V DC/50mA max., ON voltage 1.5 V or lower
- ◆ **Output update cycle** 0.1 seconds (100 msec)
- ◆ **Setting/selection** Individual setting (individual output), selectable from 21 types  
Details are the same as those for event outputs.  
(However, LOGIC can be assigned to only DO1 to DO5. Direct can be assigned to only DO6 to DO13 with communication option.)  
Details of setting range, hysteresis, action delay time and standby action are the same as those for event outputs.
- ◆ **Output characteristics switching** Normal open and normal close selectable
- ◆ **Isolation** Insulated between DO and various I/O, or DO and the system  
Not insulated between DOs

## 19-7 External Control Input (DI)

- ◆ **Number of inputs** 10 points in total: standard 4 and 6 optional
  - DI1 to DI4 4 points
  - DI5 to DI10 6 points (optional)
- ◆ **Input rating** Non-voltage contact or open collector
  - Input specifications
  - Photocoupler input
  - 5 V DC, 2.5mA max. voltage application per 1 input
  - Input holding time
  - 0.1 seconds (100 msec)
- ◆ **Setting/selection** Individual setting (individual input), selectable from 10 types
 

Input types	<ul style="list-style-type: none"> <li>1) None No action (no assignment)</li> <li>2) MAN Switching of control output between auto/manual (when ON: manual)</li> <li>3) REM Switching of REM SV/LOCAL SV setting (when ON: REM SV setting)</li> <li>4) AT Switching of AT execution/stop (at ON "edge": AT execution)</li> <li>5) STBY Switching of control execution/standby (when ON: standby)</li> <li>6) ACT Switching of direct/reverse action on Output 1 characteristics (when ON: direct action)</li> <li>7) ACT2 Switching of direct/reverse action on Output 2 characteristics (when ON: direct action)</li> <li>8) Pause Switching of pause/resume of ramp control (when ON: ramp pause)</li> <li>9) LOGIC Logic operation (when ON: execution of logic operation and output to EV or DO)</li> <li>10) EXT_SV Multi-SV switching by DI7 to DI10 (only when DI option is selected)</li> </ul>
-------------	--
- ◆ **Isolation** Insulated between DI and various I/O, or DI and the system  
Not insulated between DIs.

## 19-8 Logic Operation Functions

- ◆ **Number of logic operation outputs**  
 Assignable to 8 points in total: EV1 to EV3 3 points, DO1 to DO5 5 points  
 DO4 and DO5 are exclusively for timer and counter operation.
- ◆ **Number of logic operation inputs**  
 10 external control input points, DI1 to DI10, can be assigned individually to source 1 and source 2
- ◆ **Input logic conversion** Input logic conversion possible individually on source 1 and source2 (EV1 to EV3, DO1 to DO3 output)
  - 1) BUF By external control input logic
  - 2) INV Inversion of external control input logic
  - 3) FF Flip-flop logic operation of external control input
- ◆ **Logic operation (1)** Logic operation output by source 1 and source 2 (EV1 to EV3, DO1 to DO3 output)
  - 1) AND Output by logical product
  - 2) OR Output by logical sum
  - 3) XOR Output by exclusive OR
- ◆ **Logic operation (2)** Logic operation output by cause 1 (DO4, DO5 output)
  - 1) Timer operation OFF, 1 to 5000 seconds
  - 2) Counter operation OFF, 1 to 5000 counts

## 19-9 Heater Break Alarm (option)

- ◆ **Alarm action**  
 HBA alarm ON when control output is ON and heater break is detected  
 HLA alarm ON when control output is OFF and heater loop error is detected  
 Alarm detection HBA is detected at heater current  $\leq$  setting current value, when control output is ON  
 HLA is detected at heater current  $\geq$  setting current value, when control output is OFF  
 Hysteresis at heater break or loop error detection 0.2 A  
 Remote input cannot be used when heater break alarm is selected.
- ◆ **Current detection** Heater current detection by external CT (supplied CT for exclusive use/single phase)
  - Current detection selection Selectable from Control Output 1 or Control Output 2 only when control output is Y or P
  - Sampling cycle 0.2 seconds (200 ms)
  - Minimum action confirmation time 0.2 seconds (200 msec) or longer (regardless of whether control output is ON or OFF)
- ◆ **Current setting** Heater break, heater loop alarm set individually
  - Setting range OFF, 0.1 to 50.0 A (OFF=suspension of alarm action)
  - Setting resolution 0.1 A
- ◆ **Current display** 0.0 to 55.0 A
  - Display accuracy 3% FS (sine wave 50 Hz)
  - Sampling cycle 0.2 seconds (200 ms)
  - Minimum action confirmation time 0.2 seconds (200 msec) or longer (regardless of whether control output is ON or OFF)
- ◆ **Output** Assigned to EVENT, DO output
  - Output hold Selectable between Lock mode and Real mode
- ◆ **Isolation** Insulated between CT input and DI input, or CT input and various outputs  
 Not insulated between CT input and sensor input, or CT input and the system

## 19-10 Analog Output (option)

- ◆ **Number of outputs** Maximum 2, Ao1, Ao2 individual setting, individual output  
Only Ao1 when sensor power supply (optional) is selected
- ◆ **Output types (assignments)**  
Selectable from 5 types
  - 1) PV Measured value (measured value in execution)
  - 2) SV Set value (set value in execution)
  - 3) DEV Deviation value (measured value in execution - set value in execution)
  - 4) OUT1 Control Output 1
  - 5) OUT2 Control Output 2 (in 2-output specification)
- ◆ **Output rating** Individual selection (individual output)  
0 to 10 mV DC/output resistance 10Ω  
0 to 10 V DC/load current 2 mA max.  
4 to 20mA DC/load resistance 300Ω max.
- ◆ **Output accuracy** ±0.1% FS (of indicated value)
- ◆ **Output resolution** Approx. 1/14000
- ◆ **Output update cycle** 0.1 second (100 msec)
- ◆ **Output scaling** PV, SV within measuring range: DEV within -100.0 to 100.0%;  
OUT1 and OUT2 within 0.0 to 100.0%; reverse scaling possible
- ◆ **Isolation** Insulated between analog outputs and various I/O, or analog outputs and the system  
Not insulated between analog outputs (Ao1 and Ao2)

## 19-11 Sensor Power Supply (option)

- ◆ **Number of outputs** 1  
Output from Analog Output 2 (Ao2) terminal  
When the sensor power supply is selected, Analog Output 2 (Ao2) is unusable.
- ◆ **Output rating** 24 V DC/25 mA max.
- ◆ **Isolation** Sensor power supply insulated from various I/O and system, analog output 1 and system

## 19-12 Communication (option)

- ◆ **Communication type**  
RS-232C, RS-485
- ◆ **Communication system**  
RS-232C 3-line half-duplex system  
RS-485 2-line half-duplex multidrop (bus) system
- ◆ **Communication distance**  
RS-232C 15 m max.  
RS-485 500 m max. (depending on connection conditions)
- ◆ **Number of connectable devices**  
RS-232C 1  
RS-485 32 (differs depending on connection conditions including the host)
- ◆ **Synchronization system**  
Start-stop synchronization
- ◆ **Communication speed**  
2400, 4800, 9600, 19200 bps
- ◆ **Communication (device) address**  
1 to 98
- ◆ **Communication delay time**  
1 to 50 msec
- ◆ **Communication memory mode**  
EEP, RAM, r\_E
- ◆ **Communication protocol (1)** SHIMADEN protocol
  - Data length 7-bit, 8-bit
  - Parity EVEN, ODD, NONE
  - Stop bit 1-bit, 2-bit
  - Control code STX\_ETX\_CR, STX\_ETX\_CRLF, @\_: \_CR
  - Checksum (BCC) ADD, ADD\_two's cmp, XOR, None
  - Communication code  
ASCII
- ◆ **Communication protocol (2)** MODBUS ASCII mode
  - Data length 7-bit (fixed)
  - Parity EVEN, ODD, NONE
  - Stop bit 1-bit, 2-bit
  - Control code \_CRLF
  - Error check LRC check
  - Function code 03H and 06H (Hex) supported
    - 1) 03H Read data
    - 2) 06H Write data
- ◆ **Communication protocol (3)** MODBUS RTU mode
  - Data length 8-bit (fixed)
  - Parity EVEN, ODD, NONE
  - Stop bit 1-bit, 2-bit
  - Control code None
  - Error check CRC 16
  - Function code 03H and 06H (Hex) supported for
    - 1) 03H Read data
    - 2) 06H Write data



## 19-13 Infrared Communication

- ◆ **Communication system** Direct communication is possible with a PC through the infrared USB conversion adapter (sold separately)
- ◆ **Number of connectable devices**  
1
- ◆ **Infrared communication specification**
  - Synchronization system Start-stop synchronization
  - Communication speed 9600 bps
  - Data format 7E1 (7 bits, even parity, 1 stop bit)
  - Control code STX\_ETX\_CR
  - Checksum (BCC) ADD
  - Communication code ASCII
- ◆ **Communication protocol** Shimaden standard (extended) protocol

## 19-14 General Specifications

- ◆ **Data storage** Non-volatile memory (EEPROM)
- ◆ **Operating environment conditions**
  - Temperature -10 to 50°C
  - Humidity 90% RH max. (no dew condensation)
  - Elevation 2000 m above sea level or lower
  - Category II
  - Pollution class 2
- ◆ **Storage temperature** -20 to 65°C
- ◆ **Power voltage** 100 to 240 V AC  $\pm 10\%$  50/60 Hz
- ◆ **Power consumption** Max. 22 VA
- ◆ **Input noise removal ratio**
  - Normal mode 40 dB min. (50/60 Hz)
  - Common mode 120 dB min. (50/60 Hz)
- ◆ **Applicable standards**
  - Safety IEC61010-1 and EN61010-1  
IEC61010-2-030 and EN61010-2-030
  - EMC EN61326-1
- ◆ **Insulation resistance**
  - Across I/O terminals and power terminal : 500 V DC 20M $\Omega$  min.
  - Across power terminals and ground terminal : 500 V DC 20M $\Omega$  min.
- ◆ **Dielectric strength**
  - Across I/O terminals and power terminal : 3000 V AC for 1 minute
  - Across power terminals and ground terminal : 1500 V AC for 1 minute
- ◆ **Protective structure** Front operating panel only is dust-proof and drip-proof.  
(equivalent to IP66, NEMA4X)
- ◆ **Case material** PC resin molding (equivalent to UL94V-1)
- ◆ **External dimensions (H x W x D)**
  - 96 x 96 x 111 mm (panel depth:100 mm)
  - Panel depth is 112 mm when terminal cover is installed.
- ◆ **Mounting** Imbedded in panel (using mounting fixtures)
- ◆ **Thickness of usable panel** 1.0 to 8.0 mm
- ◆ **Size of panel cutout** 92 (H) x 92 (W) mm
- ◆ **Weight** 600 g max.

This page left intentionally blank

产品中有毒有害物质或元素的名称及含量

部件名称	有毒有害物质或元素					
	铅 (Pb)	汞 (Hg)	镉 (Cd)	六价铬 (Cr (VI))	多溴联苯 (PBB)	多溴二苯醚 (PBDE)
印制电路板	×	○	○	○	○	○
电子元器件	×	○	○	○	○	○
接线端子	○	○	○	○	○	○
外壳	○	○	○	○	○	○
○：表示该有毒有害物质在该部件所有均质材料中的含量均在SJ/T 11363-2006 标准规定的限量要求以下。 ×：表示该有毒有害物质至少在该部件的某一均质材料中的含量超出SJ/T 11363-2006 标准规定的限量要求。						

The contents of this Instruction Manual are subject to change without notice.

**Temperature and Humidity Control Specialists**

**SHIMADEN CO., LTD.**

<http://www.shimaden.co.jp/>

Head Office: 2-30-10 Kitamachi, Nerima-ku, Tokyo 179-0081 Japan  
 Phone: +81-3-3931-7891 Fax: +81-3-3931-3089 E-mail: exp-dept@shimaden.co.jp

PRINTED IN JAPAN